

# OLIGO



SYSTEMLEUCHTEN  
SYSTEM LUMINAIRES

## LEGENDE

Detailinformationen ab Seite 20

## PICTOGRAM KEY

Detailed information from page 20



Die Leuchte besitzt ein Bedienelement für die Funktionen An/Aus und Dimmen.

The luminaire has a control element for On / Off and dimming.



CASAMBI  
ON BOARD

Die Leuchte hat eine integriertes Casambimodul und ist über App steuerbar.

The luminaire has an integrated Casambi module and can be controlled via app.



SMARTHOME  
OPTION

Über Zubehör kann die Leuchte in Smarthome Systeme eingebunden werden.

The luminaire can be integrated into Smarthome systems via accessories.



TUNABLE  
WHITE

Die Farbtemperatur der Leuchte ist von 2200 K (warmweiß) bis 5000 K (kaltweiß) einstellbar.

The colour temperature of the luminaire is adjustable from 2200 K (warm white) to 5000 K (cool white).



MESH  
CONTROL

Dem Bedienelement der Leuchte können Funktionen zugeordnet werden, die über das Schalten und Dimmen hinausgehen, z.B. das Ändern der Farbtemperatur. Auch die Steuerung von anderen Leuchten, Gruppen oder Szenen ist möglich.

Functions that go beyond switching and dimming can be assigned to the control element of the luminaire, e.g. changing the light temperature. It is also possible to control other luminaires, groups or scenes.

## LEGENDE

Detailinformationen ab Seite 20

## PICTOGRAM KEY

Detailed information from page 20



LICHTANTEILE  
UP / DOWN  
STEUERBAR

Der obere bzw. untere Lichtanteil lässt sich über App oder ein Bedienelement an der Leuchte einstellen.

The upper or lower light proportion can be adjusted via app or adjust a control element on the luminaire.



FOKUSSIERTBAR

Der Abstrahlwinkel kann stufenlos eingestellt werden.

The beam angle can be adjusted continuously.



EXTERN  
DIMMBAR

Die Leuchte kann je nach Leuchtmittel extern gedimmt werden.

The luminaire can be dimmed externally depending on the lamp.



FÜR RETROFIT  
GEEIGNET

Die Leuchtenfassung ist für Retrofitleuchtmitteln geeignet.

The luminaire socket is suitable for retrofit lamps.



# FEEL THE LIGHT

Es kann betören und verheißen, verlocken und verzaubern. Licht ist Poesie für Mensch und Raum.

Die Kombination von LED und neuen digitalen Technologien eröffnet eine Vielzahl von Möglichkeiten für mehr Licht- und Lebensqualität.

Stilsicheres Design und hochwertige Materialien, verbunden mit innovativen Formen der Lichtsteuerung bieten zeitgemäßen Lichtkomfort. Sie machen Systemleuchten von OLIGO zu einem gestalterischen Highlight in Wohnraum und Objekt.

Lassen Sie sich von unseren Lichtideen inspirieren.

It can beguile and promise, entice and enchant. Light is poetry for people and space.

The combination of LED and new digital technologies opens up a multitude of possibilities for more quality of light and life.

Stylish design and high-quality materials combined with innovative forms of lighting control offer contemporary lighting comfort. They make system luminaires from OLIGO a design highlight in living spaces and buildings.

Let yourself be inspired by our lighting ideas.



# INHALT

## CONTENT

---

Systemleuchten  
für Wohnraum und Objekt  
2022

System luminaires  
for living space and object  
2022

			Seite Page
feel the light	Über uns und die OLIGO <sup>group</sup> About us and the OLIGO <sup>group</sup>		7
	Besondere Funktionen unserer Leuchten Special functions of our luminaires		16
	Neuheiten Novelties		24
	Auszeichnungen Awards		26
24 V	LED-System	SMART.TRACK   SMART.POINT	29
230 V	Schienensystem Track system	CHECK-IN	79
		PHASE	133
12 V	Schienensystem Track system	READY FOR TAKE OFF	171
		Steckkontaktsystem Plug connector system	209
Zubehör Accessories	Smarthome und Dimmer Smarthome and dimmer		237
	Transformatoren und Schaltnetzteile Transformers and switching power supplies		240
	Leuchtmittelzubehör Luminaire accessories		244
Anhang Appendix	Register nach Produktname Register by product name		248
	Register nach Artikelnummer Register by article number		250
	Bestellinformationen und technische Hinweise Ordering information and technical notes		254





# Oligo<sup>group</sup>

## OLIGO | RSL | SURFACE CONTROLS

Die Oligo<sup>group</sup> steht für moderne Lichttechnik, die das Leben komfortabler, Gebäude individueller und Produktionsprozesse effizienter macht. Dahinter stehen die Unternehmen OLIGO Lichttechnik GmbH sowie die RSL Lichttechnik GmbH in Sankt Augustin und Oligo surface controls in Lenzen.

Unsere Unternehmen eint die Faszination für das Phänomen Licht. Gemeinsam nutzen wir unser technologisches Know-how und entwickeln zukunftsweisende Lichtlösungen für verschiedene Anwendungsgebiete: Licht zum Wohnen und Einrichten, Licht als phantastische Idee und Licht zum Prüfen und Optimieren.

The Oligo<sup>group</sup> stands for modern lighting technology that makes life more comfortable, buildings more individual and production processes more efficient. The companies behind it are OLIGO Lichttechnik GmbH, RSL Lichttechnik GmbH in Sankt Augustin and Oligo surface controls in Lenzen.

Our companies are united by a fascination for the phenomenon of light. Together we use our technological know-how and develop innovative lighting solutions for different areas of application: Light for living and furnishing, light as a fantastic idea and light for testing and optimising.



# OLIGO

## LICHT ZUM WOHNEN UND EINRICHTEN

Seit 1987 entwerfen, entwickeln und fertigen wir hochwertige Leuchten für den Wohnraum und ausgewählten Shop- und Objektbereich mit dem höchsten qualitativen Anspruch vollständig in Deutschland.

Wir vertrauen dabei stets auf unsere enge und langjährige Zusammenarbeit mit spezialisierten Partnern und Dienstleistern aus der Region und treffen mit größter Sorgfalt Entscheidungen hinsichtlich der Materialauswahl. Wir verwenden dauerhafte Materialien wie Glas und Aluminium, um langlebige und zeitlose Begleiter zu schaffen. Neben eigens entwickelten Innovationen, wie optimierten LED-Modulen und einzigartigen Linsen und Prismatiken, bieten OLIGO Leuchten innovative Bedienelemente zum Schalten und Dimmen.

Unsere Leuchten sind nicht nur nachhaltig, innovativ und intuitiv, sondern bieten auch eine zeitgemäße Beleuchtung.

## LIGHT FOR LIVING AND FURNISHING

Since 1987, we have been designing, developing and manufacturing high-quality luminaires for the home and selected shop and contract areas with the highest quality standards entirely in Germany.

We always rely on our close and long-standing cooperation with specialised partners and service providers from the region and make decisions regarding the selection of materials with the utmost care. We use durable materials such as glass and aluminium to create long-lasting and timeless companions. In addition to innovations developed in-house, such as optimised LED modules and unique lenses and prisms, OLIGO luminaires offer innovative control elements for switching and dimming.

Our luminaires are not only sustainable, innovative and intuitive, but also offer contemporary lighting.





#### LICHT ALS PHANTASTISCHE IDEE

Unter der Marke RSL entwickeln und produzieren wir seit 1985 maßgeschneiderte Sonderleuchten, die exakt nach den Wünschen und Vorstellungen von Lichtplanern, Designern und Architekten entwickelt, konstruiert und gefertigt werden.

Wir bringen Ideen vom weißen Blatt Papier in die Anwendung und setzen damit die Impulse unserer Kunden für Innen- und Außenraumleuchten in unnachahmlicher Weise um. RSL steht für präzise Kunstfertigkeit, hochwertige Materialien, konstruktiven Erfindungsgeist und partnerschaftliche Zusammenarbeit. Daher werden vielerlei für den Sonderleuchtenbau notwendigen Komponenten maschinell und in Handarbeit in der eigenen Fertigungsstätte am Standort in Sankt Augustin gefertigt.

Wir begleiten Sie individuell und unterstützen Sie von der ersten Handskizze über Entwurf, Planung, Konstruktion und Produktion, bis hin zur Inbetriebnahme.

#### LIGHT AS A FANTASTIC IDEA

Under the RSL brand, we have been developing and producing customised special luminaires since 1985, which are developed and constructed exactly according to the wishes and ideas of lighting planners, designers and architects.

We bring ideas from a blank sheet of paper into application, implementing our customers' impulses for indoor and outdoor luminaires in an inimitable way. RSL stands for precise craftsmanship, high-quality materials, constructive inventiveness and cooperation based on partnership. This is why many of the components required for the construction of special components are manufactured by machine and by hand in the in our own production facility in Sankt Augustin, Germany.

We accompany you individually and support you from the first hand sketch to design, planning, construction and production, right up to commissioning.



D SU OL



#### LICHT ZUM PRÜFEN UND OPTIMIEREN

Oligo surface controls entwickelt und produziert als Spezialist für innovative Lichttechnologie visuelle und digitale Kontrollsysteme für hochpräzise Farbabmusterungen und Oberflächenkontrollen. Mit mehreren tausend in aller Welt installierten Anlagen gehören wir zu den international führenden Anbietern für optische Qualitätskontrollsysteme. Zu unseren Kunden zählen führende Automobilhersteller, sowie weitere führende Unternehmen aus unterschiedlichsten Branchen, wie z. B. Elektronik, Windkraft und Einrichtung.

#### LIGHT FOR TESTING AND OPTIMISING

As a specialist in innovative lighting technology, Oligo surface controls develops and produces visual and digital control systems for high-precision colour matching and surface control. With several thousand systems installed all over the world, we are one of the leading international suppliers of optical quality control systems. Our customers include leading automotive manufacturers, as well as other leading companies from a wide range of industries, such as electronics, wind power and furnishing.

## BESUCHEN SIE UNSEREN SHOWROOM VISIT OUR SHOWROOM

In unserem Showroom in Sankt Augustin bei Bonn können Sie sich umfassend über OLIGO Leuchten informieren und sich inspirieren lassen. Besuchen Sie uns und erleben die optische und materielle Qualität unserer Produkte hautnah. Um sicherzustellen, dass wir Sie individuell beraten können, bitten wir um eine vorherige Terminabsprache.

In our showroom in Sankt Augustin near Bonn, you can get comprehensive information about OLIGO luminaires and be inspired. Visit us and experience the visual and material quality of our products up close. To ensure that we can advise you individually, please make an appointment in advance.





# OLIGO IM FACHHANDEL

## OLIGO IN THE SPECIALISED TRADE

Wir arbeiten weltweit mit ausgewählten Partnern im Bereich Licht und Einrichtung zusammen und bauen unser Vertriebsnetz stetig aus.

Um ihren perfekten Ansprechpartner zu finden, laden wir Sie ein, die Händlersuche auf unserer Website zu nutzen: [www.oligo.de/storelocator/](http://www.oligo.de/storelocator/)

We cooperate worldwide with selected partners in the field of lighting and furnishing and are constantly expanding our distribution network.

To find the perfect contact for you, we invite you to use the dealer search on our website: [www.oligo.de/storelocator/](http://www.oligo.de/storelocator/)







## WENN DESIGN AUF MAGIE TRIFFT WHEN DESIGN MEETS MAGIC

Gutes Design ist mehr als nur die äußere Form. Lernen Sie die Funktionen kennen, die unsere Leuchten so besonders machen. Zum Beispiel besitzen viele unserer Leuchten eine Smarthome-Option und bieten so höchsten Komfort. Andere verzaubern durch ein magisches Erlebnis - die Steuerung der Leuchte mit einer simplen Geste.

Good design is more than just the outer form. Get to know the functions that make our luminaires so special. For example, many of our luminaires impress with a smart home option and thus offer the highest level of comfort. Others enchant with a magical experience - controlling the luminaire with a simple gesture.

HOME



41 DEGREES  
BY PIERRE LENOIR - 1960 - 1965

SINCE  
BY PIERRE LENOIR - 1960 - 1965



HUBBLE  
BY PIERRE LENOIR - 1960 - 1965



# SMARTHOME FEEL WHAT LIGHT CAN DO!



SMARTHOME  
OPTION

## CASAMBI

### EINFACH CLEVER

Casambi ist eine einfach zu integrierende, kostenlose Software zur mobilen Steuerung von Einzelleuchten und Beleuchtungssystemen. Sie zeichnet sich durch einfache Integrierbarkeit, einfachen technischen Aufbau, kabellose Installation und eine intuitive Steuerung via Smart Phone oder Tablet aus.

Auch bestehende Beleuchtungsstrukturen und konventionelle Lichtschalter können über ein nachträglich installierbares Schaltermodul in die smarte Lichtsteuerung integriert werden. Damit eignet sich Casambi insbesondere für die Nachrüstung in Bestandsbauten.

## HomeMatic

### DIE SMARTE KOMPLETTLÖSUNG

HomeMatic ist ein gewerkeübergreifendes Smarthome-System für die intelligente Gebäudesteuerung via Funk. Mit dem System lassen sich nicht nur Licht-, sondern beispielsweise auch Gebäudeüberwachungsfunktionen realisieren. Es bietet sich für die Nachrüstung ebenso wie für den Neubau an.

Die einzelnen angeschlossenen Geräte, wie Jalousie, Heizung, Zutrittskontrolle und Wettersensoren, können bequem per Smartphone und Tablet, über eine fest eingebaute Zentrale, per Fernbedienung oder über die PC-Software gesteuert werden. HomeMatic ist ein Produkt des deutschen Herstellers eQ-3.



### DALI – DIGITAL ADDRESSABLE LIGHTING INTERFACE

Als digitaler, offener Standard bietet DALI eine Vielzahl von Produkten und Anwendungsmöglichkeiten, die über eine verteilte Intelligenz und automatisierte Funktionen, wie individuelle Statusmeldungen oder Systemüberwachungen, verfügen.

Schnittstellen zu komplexen Systemen für die Gebäudesystemtechnik, wie zum Beispiel KNX, LON oder DMX, ermöglichen es, DALI-Komponenten mit einer vorhandenen Gebäudeleittechnik zu kombinieren.

Mit den neuen 24 Volt LED-Systemleuchten bietet OLIGO die Möglichkeit, Leuchten mittels DALI-fähiger Komponenten in die Gebäudeautomation einzubinden. Ein dreipoliger Steckkontakt mit integriertem Signalpol ermöglicht die Konfiguration von Lichtnetzen für größere kommerzielle Anwendungen, oder auch allein stehende Systeme für kleinere Installationen. Auch die energieeffiziente Sanierung bestehender dreiphasiger Beleuchtungssysteme im Objekt lässt sich mit 24 Volt LED-Systemleuchten realisieren.

OLIGO

### SIMPLY CLEVER

Casambi is an easy-to-integrate, free software for mobile control of individual luminaires and lighting systems. It features easy integration, simple technical design, wireless installation and intuitive control via smart phone or tablet.

Existing lighting structures and conventional light switches can also be integrated into the smart lighting control system via a switch module that can be retrofitted. This makes Casambi particularly suitable for retrofitting in existing buildings.

### THE SMART COMPLETE SOLUTION

HomeMatic is a multi-trade smarthome system for intelligent building control via radio. The system can be used to implement not only lighting functions, but also building monitoring functions, for example. It is suitable for retrofitting as well as for new buildings.

The individual connected devices such as blinds, heating, access control and frahling sensors can be conveniently controlled via smartphone and tablet, via a permanently installed central control unit, via remote control or via the PC software. HomeMatic is a product of the German manufacturer eQ-3.

### DALI - DIGITAL ADDRESSABLE LIGHTING INTERFACE

As a digital, open standard, DALI offers a wide range of products and application possibilities with distributed intelligence and automated functions such as individual status messages or system monitoring.

Interfaces to complex systems for building control, such as KNX, LON or DMX, make it possible to combine DALI components with an existing building control system.

With the new 24 Volt LED system luminaires, OLIGO offers the possibility of integrating luminaires into the building automation system by means of DALI-compatible components. A three-pole plug-in contact with integrated signal pole enables the configuration of lighting networks for larger commercial applications, or stand-alone systems for smaller installations. The energy-efficient refurbishment of existing three-phase lighting systems in lighting systems in buildings can also be realised with 24 V LED system luminaires.



## SMARTES LICHT NUR EINEN FINGERTIPP ENTFERNT SMART LIGHT JUST A TAP AWAY

### Casambi

Ob Zuhause oder im gewerblichen Umfeld: Smarte Systemlösungen und Möglichkeiten zur individuellen Lichtsteuerung bereiten die Grundlage für mehr Lichtkomfort.

Casambi bietet die Möglichkeit der mobilen Steuerung von Leuchten. Basierend auf dem Bluetooth 4.0 LE Standard ist eine intuitive Steuerung via Smartphone oder Tablet möglich.

Mit Zubehör, wie dem Funktaster XPRESS, kann das Licht nach einmaliger Einrichtung auf Wunsch auch unabhängig von der Casambi App gesteuert werden. Alternativ können bestehende Wandtaster mithilfe eines Tasterinterface auf Casambisteuerung umgerüstet werden.

Zusätzlicher Komfort entsteht durch die Möglichkeit, Leuchten in Gruppen oder Szenen zusammenzufassen. Dadurch können mehrere Leuchten simultan gesteuert werden.

Whether at home or in a commercial environment: smart system solutions and options for individual lighting control prepare the ground for more lighting comfort.

Casambi offers the possibility of mobile control of luminaires. Based on the Bluetooth 4.0 LE standard, intuitive control via smartphone or tablet is possible.

With accessories such as the XPRESS wireless pushbutton, the light can also be controlled independently of the Casambi app if desired after a one-time setup. Alternatively, existing wall switches can be converted to Casambi control by using a push-button interface.

Additional convenience is provided by the possibility of combining luminaires in groups or scenes. This allows several luminaires to be controlled simultaneously.



CASAMBI  
ON BOARD



### Tunable White

Einige Modelle besitzen neben der Möglichkeit die Helligkeit stufenlos zu verändern, auch die Option die Farbtemperatur stufenlos zwischen 2200 K (Warmweiß) und 5000 K (Kaltweiß) einzustellen. Diese Fähigkeit wird Tunable White genannt.

Ob konzentriertes Arbeiten oder ein gemütliches Candlelight dinner, unsere Leuchten passen sich jederzeit und ganz individuell Ihren Wünschen und Bedürfnissen an.

In addition to the possibility of continuously changing the brightness, some models have the option of continuously adjusting the colour temperature between 2200 K (warm white) and 5000 K (cool white). This capability is called Tunable White.

Whether for concentrated work or a cosy candlelight dinner, our luminaires can be adjusted to your wishes and needs at any time and completely individually.



TUNABLE  
WHITE



### Mesh Control

Bedienelemente, wie z. B. die Gestensteuerung, bieten ab Werk die Funktionen An/Aus und Dimmen. Über die Casambi App können den Bedienelementen andere Funktionen zugeordnet werden. Kombiniert mit der Gruppenfunktion der App entstehen spannende Möglichkeiten der Lichtsteuerung.

Beispiel: Bei einer dreiflammigen Leuchte kann so über die Gestensteuerung des ersten Pendels die Helligkeit der gesamten Leuchte eingestellt werden, während über die Gestensteuerung des zweiten Pendels die Lichtfarbe ausgewählt wird. Über die Gestensteuerung des dritten Pendels werden alle Leuchten im Raum aus- und eingeschaltet bzw. gedimmt.

Control elements such as the gesture control offer the functions on/off and dimming ex works. Other functions can be assigned to the control elements via the Casambi app. Combined with the group function of the app exciting lighting control possibilities are created.

Example: With a three-lamp luminaire, the brightness of the entire luminaire can be adjusted via the gesture control of the first pendant, while the light colour is selected via the gesture control of the second pendant. The gesture control of the third pendant switched off, on or dimmed all luminaires in a room.



MESH  
CONTROL

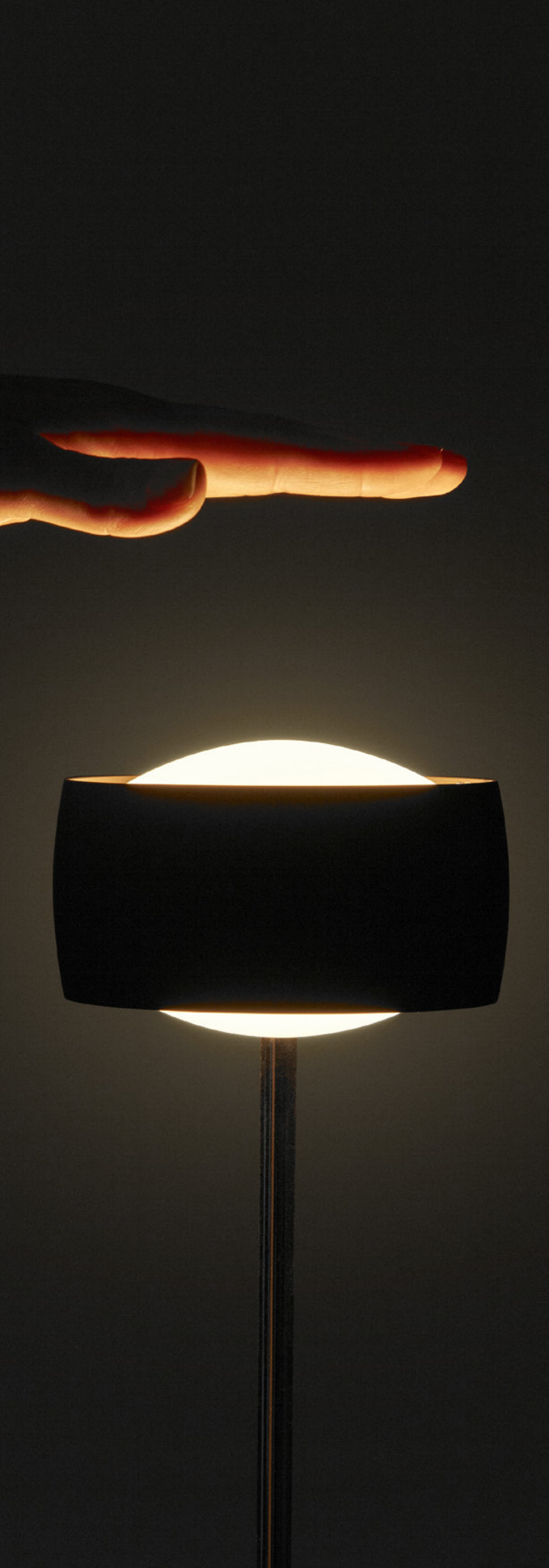

ES IST EIN MAGISCHES  
ERLEBNIS, DAS LICHT  
MIT EINER GESTE ZU  
STEUERN.

IT IS A MAGICAL  
EXPERIENCE TO  
CONTROL THE LIGHT  
WITH A GESTURE.

#### Gestensteuerung | Gesture control

Lichtkomfort zeigt sich in einem ausgefeilten Bedienkonzept. Eine dezente Handbewegung genügt, um das Licht zu steuern. Die berührungslose Gestensteuerung macht das Schalten und Dimmen von Leuchten zu einem beinahe magischen Erlebnis. Diese innovative Form der Leuchtensteuerung wurde mit dem Plus X Award für Innovation und Bedienkomfort ausgezeichnet.

Lighting comfort is reflected in a sophisticated operating concept. A discreet hand movement is enough to control the light. The touch-free gesture control makes switching and dimming luminaires an almost magical experience. This innovative form of luminaire control was awarded the Plus X Award for innovation and ease of use.



GESTEN-  
STEUERUNG







#### Dimmtaster | Dimming push-button

Ein Taster dient als funktionales Bedienelement und ermöglicht das stufenlose Dimmen und Schalten an der Leuchte.

A push-button serves as a functional control element and enables stepless dimming and switching on the luminaire.



#### Berührungsdimmer | Touch dimmer

Bei dieser intuitiven Form der Leuchtensteuerung wird die Helligkeit der Leuchte durch einfaches Berühren der Sensorfläche geregelt.

With this intuitive form of luminaire control, the brightness of the luminaire is regulated by simply touching the sensor surface.

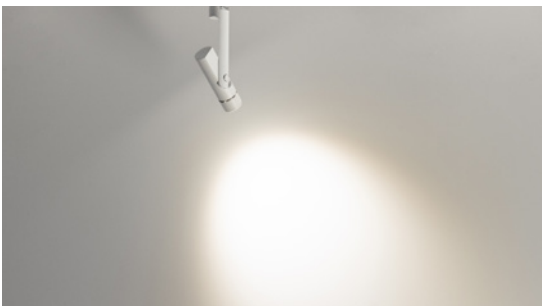

#### Fokussierbar | Focusable

Bei einigen Leuchten kann der Abstrahlwinkel durch eine stufenlos verstellbare Linse angepasst werden.

With some luminaires, the beam angle can be adjusted by means of a continuously adjustable lens.



#### Extern dimmbar | Externally dimmable

Einige unserer Leuchten sind extern über klassische Drehdimmer steuerbar. Der Betrieb ist von verschiedenen Faktoren abhängig und muss im Einzelfall geprüft werden.

Some of our luminaires can be controlled externally via classic rotary dimmers. The functioning depends on various factors and has to be checked on a case-by-case basis.

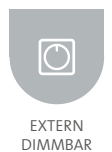

#### Retrofit geeignet | Retrofit suitable

Die meisten unserer Leuchten mit konventioneller Fassung sind sowohl für LED Retrofits als auch für klassische Halogen-Leuchtmittel geeignet.

Most of our luminaires with conventional lamp-holders are suitable for both LED retrofits and classic halogen light sources.





# NEUHEITEN NOVELTIES

Innovative Bauformen, lange Lebensdauer und intuitive Möglichkeiten der Lichtsteuerung machen OLIGO Leuchten zu einem effizienten und gestalterischen Highlight in Wohnraum und Objekt. Lassen Sie sich von unseren Lichtideen inspirieren.



## SLACK-LINE LICHTMODULE INS SMART.TRACK SYSTEM ADAPTIEREN

Exklusiv-Sortiment: Bezug nur über ausgewählte Fachhändler

„Am Anfang stand eine einfache Schlaufe, am Ende ein hochvariables System“ - dieser Satz fasst die Entwicklung von SLACK-LINE treffend zusammen. Denn das Konzept der exklusiven und modularen Einzelleuchterserie basiert auf der innovativen Idee, verschiedenste Lichtmodule in eine oder mehrere Seilschlaufen einzuhängen und beliebig kombinieren zu können. Ganz gleich, ob Ambiente- oder Arbeitsplatzbeleuchtung, direktes oder indirektes Licht, Punkt- oder Flächenlicht.

Dank der neuen Adapter stehen das exklusive SLACK-LINE Konzept und die dazugehörigen Lichtmodule nun auch für das SMART.TRACK Schienensystem zur Verfügung. Die Seilschlaufen können je nach Adaptervariante längs oder quer zum Schienenverlauf angebracht werden.

Harmonisch ausgewählte Farbtöne, gepaart mit einer zart schimmernden Oberfläche, laden ein zur Variation der Module. Doch die Flexibilität geht noch weiter: Farbe und Intensität des Lichts lassen sich ohne weiteres Zubehör per Funk steuern, wahlweise jedes Modul allein, mehrere Module in einer Gruppe oder auch gemeinsam mit weiteren Leuchten.

SLACK-LINE bietet eine innovative Lichterfahrung mit allen Sinnen. Tauchen Sie ein in die neue Welt des Lichts.

SMART.TRACK System ab Seite 29.

SLACK-LINE Lichtmodule ab Seite 55.

Adapter auf Seite 69.

Innovative designs, long service life and intuitive lighting control options make OLIGO luminaires an efficient and creative highlight in living spaces and buildings. Let our lighting ideas inspire you.



## ADAPT SLACK-LINE LIGHT MODULES TO THE SMART.TRACK SYSTEM

Exclusive range: Purchase only via selected dealers

“In the beginning there was a simple loop, in the end a highly variable system“ - this sentence aptly sums up the development of SLACK-LINE. Because the concept of the exclusive and modular lighting system is based on the innovative idea of hooking the respective light modules into a rope loop and thus being able to combine them as required. No matter whether ambient or workplace lighting, direct or indirect light, point or area light.

With the new adapters, the exclusive SLACK-LINE concept and the corresponding light modules are now also available for the SMART.TRACK track system. The cable loops can be attached lengthwise or crosswise to the track, depending on the adapter variant.

Harmoniously selected colour shades, paired with a delicately shimmering finish, invite you to vary the modules. But the flexibility goes even further: the colour and intensity of the light can be controlled by wireless control without any additional accessories, either each module alone, several modules in a group or together with other luminaires.

SLACK-LINE offers an innovative lighting experience for all the senses. Immerse yourself in the new world of light.

SMART.TRACK system from page 29.

SLACK-LINE light modules from page 55.

Adapter on page 69.

# AUSZEICHNUNGEN AWARDS

## KONZENTRATION AUF DAS WESENTLICHE

OLIGO leitet sich aus dem Griechischen „oligós“ ab und bedeutet „wenig“. Dieser Leitgedanke einer reduzierten Formensprache bestimmt unseren Designanspruch. Mit Leichtigkeit möchten wir Design und Licht inszenieren: als glanzvolles Erlebnis oder in klarer Sachlichkeit, als helle Freude oder optischen Zauber.

## IMMER WIEDER AUSGEZEICHNET

Die Konzentration auf das Wesentliche führt zu dezenten, kompakten Leuchten mit beeindruckender Lichtleistung und finesse-reicher Lichttechnik. Durch die gestalterische Arbeit von Team OLIGO, aber auch in Zusammenarbeit mit namhaften Designbüros entstehen lichttechnische Meisterwerke, die immer wieder besondere Anerkennung finden.

## CONCENTRATION ON THE ESSENTIAL

OLIGO is derived from the Greek "oligós" and means "little". This guiding principle of a reduced formal language determines our design aspirations. We want to stage design and light with lightness: as a glamorous experience or in clear objectivity, as bright joy or optical magic.

## ALWAYS EXCELLENT

Concentrating on the essentials results in discreet, compact luminaires with impressive light output and finesse-rich lighting technology. Thanks to the creative work of Team OLIGO, but also in cooperation with renowned design offices, lighting masterpieces are created that repeatedly receive special recognition.

### Reddot Design Award



reddot design award  
winner

2011

TRINITY  
Design: EsserKnop Industriedesigner

2003

CHECK-IN  
Design: Ralf Keferstein

2001

GATSBY FINE  
Design: Ralf Keferstein

1998

PROP-ELLE  
Design: Klaus Liese

1997

PULL-IT I  
Design: Ralf Keferstein

### iF Product Design Award



2014

GLANCE  
Design: Ottenwälder & Ottenwälder

2008

BOSS  
Design: Ralf Keferstein

2008

CHECK-IN  
Design: Ralf Keferstein

1998

PULL-IT I  
Design: Ralf Keferstein

### Design PLUS

DESIGN PLUS  
powered by: light+building

2020, Best of

BREAK-IT  
Design: OLIGO, HYVE

Designpreis der  
Bundesrepublik Deutschland



Designpreis der  
Bundesrepublik  
Deutschland  
Nominiert

2009, Nominiert

BOSS  
Design: Ralf Keferstein

2004, Nominiert

CHECK-IN  
Design: Ralf Keferstein

2002, Nominiert

Pendelleuchte GATSBY  
Design: Ralf Keferstein

Interior Innovation  
Award



2015, Winner

FLAVIA Lichtobjekt  
Design: Ottenwälder & Ottenwälder

2014, Selection

GLANCE  
Design: Ottenwälder & Ottenwälder

2012, Winner

TRINITY  
Design: EsserKnop Industriedesigner

German Design Award



2018, Winner

Tischleuchte KELVEEN  
Design: OLIGO

2015, Special Mention

DECENT MAX  
Design: OLIGO

2013, Special Mention

TRINITY  
Design: EsserKnop Industriedesigner

Leuchte des Jahres



2021, Winner

YANO  
Design: Klaus Liese

2016, 2. Platz

RIO  
Design: OLIGO

2014, 3. Platz

GLANCE  
Design: Ottenwälder & Ottenwälder

2013, 3. Platz

IXO  
Design: Christoph Niedeggen

2011, 2. Platz

TRINITY  
Design: EsserKnop Industriedesigner

2009, Winner

GRACE UNLIMITED  
Design: Ralf Keferstein

2006, 2. Platz

BEL-AIR  
Design: M. Kleinhenn, R. Keferstein

Plus X Award



2017

SMART.TRACK  
Design: OLIGO

2012

Berührungslose Gestensteuerung  
Touchless gesture control:  
YANO  
GRACE  
GLANCE  
PALÃO  
KENDO  
DECENT  
DECENT MAX  
TROFEO

Focus Open  
Design Award



Focus Open 2014  
Silver

2014, Silver

GLANCE  
Design: Ottenwälder & Ottenwälder





# SMART.TRACK | SMART.POINT

## 24 V LED SYSTEM

Design: OLIGO

### BESTE LICHTQUALITÄT IM KLEINSTEN FORMAT

Einfachster mechanischer Aufbau, kleinstmöglicher Querschnitt, hochwertiges und zugleich reduziertes Design – dies sind nur einige der herausragenden Eigenschaften des 24 Volt LED-Systems. Das Sortiment, bestehend aus Strahlern, Pendelleuchten und Raumlichtern, bietet gleichzeitig Eleganz und Lichtqualität auf technisch höchstem Niveau.

Sämtliche Leuchten sind mit der bewährten Steckkontakttechnik ausgestattet. Dadurch sind die Leuchten sowohl im 24 Volt LED-Schienensystem SMART.TRACK als auch im 24 Volt LED-Steckkontaktsystem SMART.POINT einsetzbar.

Über SMART.IQ Funk-Komponenten für die digitale Lichtsteuerung können die Leuchten in die weit verbreiteten Smarthome-Systeme von Casambi und HomeMatic eingebunden werden.

Zusätzlich sind Adapter für das 230 V Schienensystem PHASE verfügbar. Optional können die Leuchten hier über DALI gesteuert werden.

### PERFECT LIGHTING, COMPACT DESIGN

The simplest mechanical design, smallest possible cross section, high quality and at the same time minimalist design – these are just a few of the outstanding features of the SMART.TRACK 24 volt LED track system. The product range consists of spotlights, pendant luminaires and room lights. It offers both elegance and light quality of the highest technical level at the same time.

All luminaires are equipped with the tried and tested plug technology. As a result, the luminaires can be used both in the SMART.TRACK 24 volt LED track system and in the SMART.POINT 24 volt LED spot system.

The luminaires can be integrated into the common Casambi and HomeMatic smart home systems using SMART.IQ wireless components for digital lighting control.

Adapters for the 230 V PHASE track system are also available. Optionally, the luminaires can be controlled via DALI here.



HUBBLE



# ÜBERSICHT OVERVIEW

## Standard Sortiment Standard range

Strahler und  
Raumlichter  
Spots and  
ambient lights



SENTRY  
36



AVIATION  
37



RIDGE  
38



HUBBLE  
39



A LITTLE BIT  
40



A LITTLE BIT MORE  
41



KELVEEN  
42



41 DEGREES  
44



FLAVIA  
45

Pendelleuchten  
Pendant  
luminaires



GRACE  
46



RIO  
48



DECENT  
50



BALINO  
51



A LITTLE BIT  
52

## Exklusiv-Sortiment: Bezug nur über ausgewählte Fachhändler Exclusive range: Purchase only via selected dealers

Pendelleuchten  
Pendant  
luminaires



CURVED  
56



GLOBE  
57



NABO  
58



CONE  
59



BREAK-IT  
60

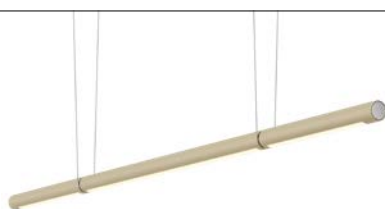

KENDO S | M | L  
62 | 63 | 64



NOVA S | M  
65

# SMART.TRACK INSTALLATION



FLAVIA | A LITTLE BIT MORE

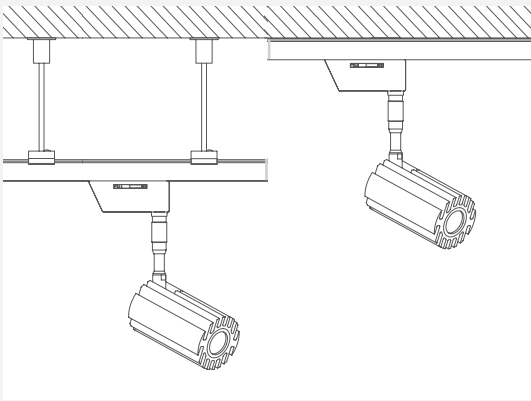

#### FLEXIBLE INSTALLATIONSMÖGLICHKEITEN

SMART.TRACK kann deckenbündig oder mit Trägern installiert werden. Die Schienenverbinder sind innenliegend und ermöglichen unabhängige Befestigungspunkte an der Decke, sodass bauliche Gegebenheiten leichter berücksichtigt werden können.

#### FLEXIBLE INSTALLATION OPTIONS

SMART.TRACK can be installed flush with the ceiling or with supports. The track connectors are internal and allow independent fixing points on the ceiling, making it easier to take structural conditions into account.

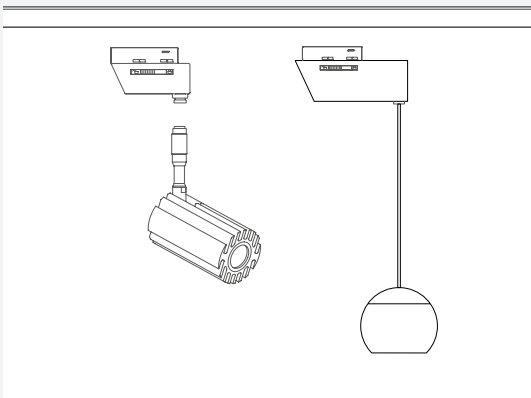

#### EINFACH UND SICHER MONTIEREN

Die meisten 24 V Leuchten werden mittels eines separat zu bestellenden Adapters an das Schienensystem angebunden. Andere Leuchten verfügen bereits über einen integrierten Schienenadapter. Die Montage des Adapters erfolgt werkzeuglos. Ein integrierter Verdrehenschutz sorgt für eine einfache und sichere Installation.

#### INSTALL EASILY AND SAFELY

Most 24 V luminaires are connected to the track system by an adapter that has to be ordered separately. Other luminaires already have an integrated adapter. The adapter is mounted without any tools. An integrated anti-twist protection ensures easy and safe installation.

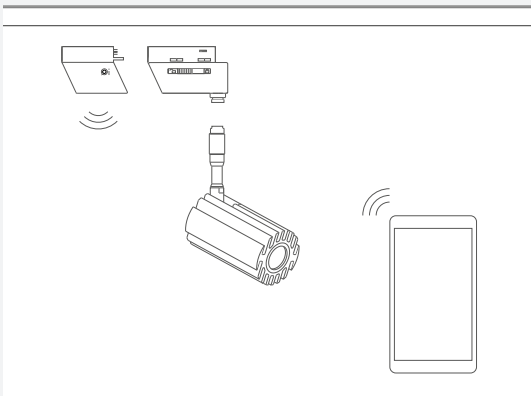

#### FUNKADAPTER FÜR LICHTSTEUERUNG

Bei Leuchten ohne integriertes Casambi-Modul kann der SMART.IQ Funkadapter genutzt werden, um eine Smarthome-Lösung zu schaffen. Der SMART.IQ Adapter wird einfach auf den Leuchtenadapter aufgesteckt. Zusätzlich sind Funkadapter für HomeMatic verfügbar.

#### WIRELESS ADAPTER FOR LIGHTING CONTROL

For luminaires without an integrated Casambi module, the SMART.IQ wireless adapter can be used retroactively to create a smarthome solution. The SMART.IQ adapter is simply plugged into the luminaire adapter. Additionally, radiocontrolled adapters for HomeMatic are available.

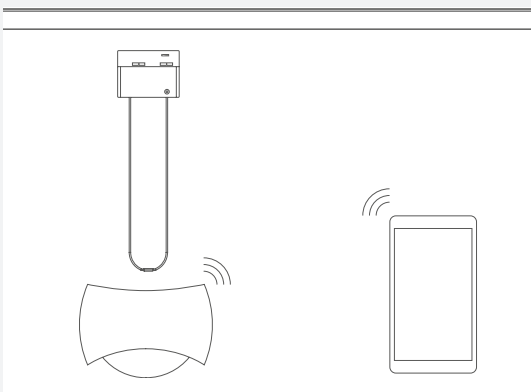

#### PERFEKTE ERWEITERUNG

Mit Hilfe von Adaptern können SLACK-LINE Lichtmodule in das Schienensystem integriert werden. Diese besitzen ab Werk ein Casambi-Modul und verfügen über erweiterte Steuerungsmöglichkeiten.

#### PERFECT EXTENSION

SLACK-LINE light modules can be integrated into the track system with the help of adapters. These have a Casambi module ex works and have extended control options.

# SMART.POINT INSTALLATION



HUBBLE

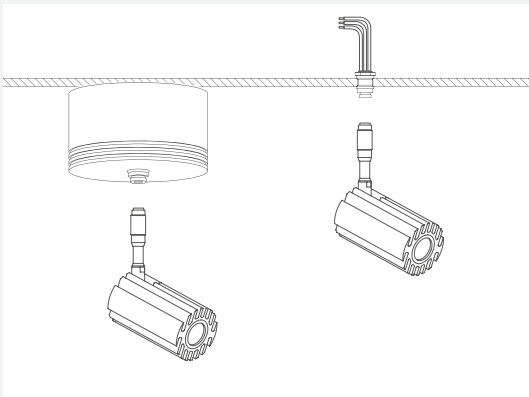

#### FLEXIBLE INSTALLATIONSMÖGLICHKEITEN

SMART.POINT kann entweder als Einbauvariante mit externem Schaltnetzteil in Hohlraumdecken oder als Aufbauvariante mit integriertem Schaltnetzteil installiert werden. Dank der Steckverbindung lassen sich die Leuchten schnell und komfortabel in Betrieb nehmen.

#### FLEXIBLE INSTALLATION OPTIONS

SMART.POINT can be installed either as a recessed version with an external switching power supply in ceilings or as a surface-mounted version with an integrated switching power supply. Thanks to the plug connection, the luminaires can be put into operation quickly and conveniently.

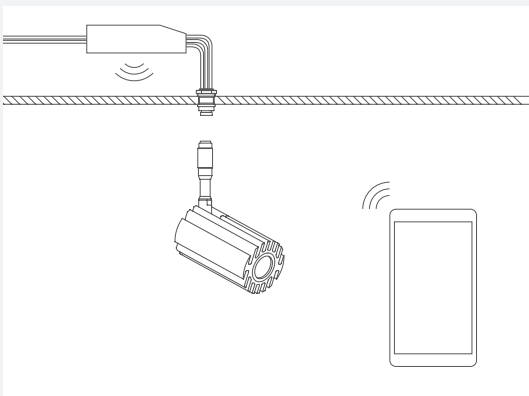

#### FUNKADAPTER FÜR LICHTSTEUERUNG

Mit dem leicht zu integrierenden SMART.IQ Funkmodul wird das SMART.POINT System im Handumdrehen in eine Smarthome-Lösung verwandelt. Das SMART.IQ Funkmodul wird einfach mit der Steckkontaktbuchse verbunden.

#### WIRELESS ADAPTER FOR LIGHTING CONTROL

With the SMART.IQ wireless module, which is easy to integrate, SMART.POINT is transformed into a smarthome solution in the blink of an eye. The SMART.IQ wireless modul is simply connected to the plug-in contact socket.

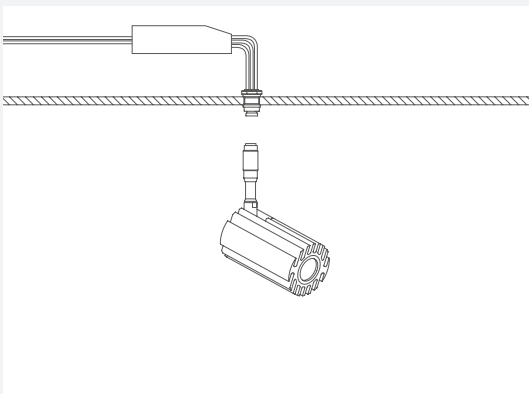

#### DALI MODUL FÜR LICHTSTEUERUNG

Mit dem leicht zu integrierenden DALI Modul ist eine leitungsgebundene Lichtsteuerung möglich. Es bietet Schnittstellen zu komplexen Systemen für die Gebäudesystemtechnik wie zum Beispiel KNX, LON oder DMX.

#### DALI MODULE FOR LIGHTING CONTROL

With the easy-to-integrate DALI module, wired lighting control is possible. It operates as an interfaces to complex systems for building system technology, such as KNX, LON or DMX.

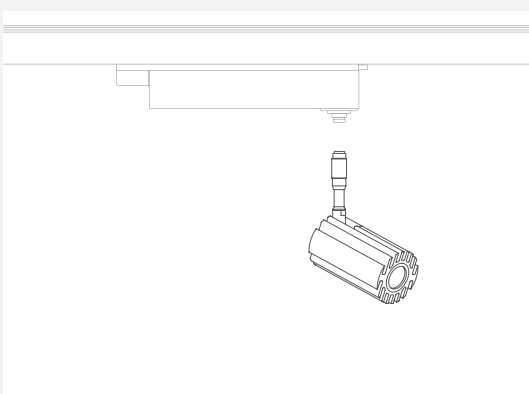

#### ADAPTION IN SCHIENENSYSTEM PHASE

Auch eine Integration in das 230 V Schienensystem PHASE ist möglich. Der Adapter ist wahlweise mit einer DALI-Steuerung versehen. Bei Aufbau des PHASE-Systems aus DALI-fähigen Komponenten kann so eine leitungsgebundene Lichtsteuerung erfolgen, siehe Kapitel PHASE ab Seite 138.

#### ADAPTION IN TRACK SYSTEM PHASE

An integration into the 230 volt PHASE track system is also possible. The adapter is optionally equipped with a DALI control. If the PHASE system is made up of DALI-capable components, a wired lighting control system can be used, see chapter PHASE from page 138.



# SENTRY



Strahler

Drehbar, schwenkbar

Aluminium

Spotlight

Rotatable, swiveling

Aluminium

LED | 1200 lm | 13,9 W | CRI >90

Leuchte Luminaire	Winkel Angle	2700 K	3000 K
Chrom matt Matt chrome	26°	20-867-60-06	20-867-70-06
	43°	20-867-61-06	20-867-71-06
Weiß matt Matt white	26°	20-867-60-21	20-867-70-21
	43°	20-867-61-21	20-867-71-21
Schwarz matt Matt black	26°	20-867-60-23	20-867-70-23
	43°	20-867-61-23	20-867-71-23

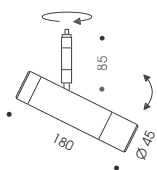

24 V DC 0,7 kg

Adapter separat bestellen: SMART.TRACK auf Seite 69, SMART.POINT ab Seite 74  
Order adapter separately: SMART.TRACK on page 69, SMART.POINT from page 74



SMARTHOME  
OPTION

SMART.TRACK | SMART.POINT

# AVIATION

Design: Böhler Design

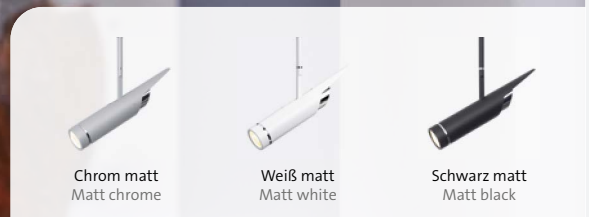

Strahler

Drehbar, schwenkbar

Aluminium

Spotlight

Rotatable, swiveling

Aluminium

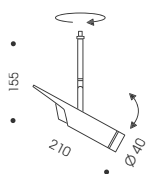

24 V DC 0,5 kg

LED | 650 lm | 8,4 W | CRI >90

Leuchte Luminaire	Winkel Angle	2700 K	3000 K
<b>Chrom matt</b> Matt chrome	23°	20-875-60-06	20-875-70-06
	41°	20-875-61-06	20-875-71-06
<b>Weiß matt</b> Matt white	23°	20-875-60-21	20-875-70-21
	41°	20-875-61-21	20-875-71-21
<b>Schwarz matt</b> Matt black	23°	20-875-60-23	20-875-70-23
	41°	20-875-61-23	20-875-71-23

Adapter separat bestellen: SMART.TRACK auf Seite 69, SMART.POINT ab Seite 74  
Order adapter separately: SMART.TRACK on page 69, SMART.POINT from page 74



# RIDGE



Chrom matt  
Matt chrome



Weiß matt  
Matt white



Schwarz matt, Chrom  
Matt black, Chrome

Strahler

Drehbar, schwenkbar

Aluminium

Spotlight

Rotatable, swiveling

Aluminium

LED | 850 lm | 8 W | 52° | CRI >90

Stange Rod	Korpus Body	2700 K	3000 K
Chrom matt Matt chrome	Chrom matt Matt chrome	20-889-21-06	20-889-31-06
Weiß matt Matt white	Weiß matt Matt white	20-889-22-21	20-889-32-21
Chrom Chrome	Schwarz matt Matt black	20-889-20-23	20-889-30-23

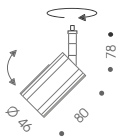

24 V DC 0,2 kg

Adapter separat bestellen: SMART.TRACK auf Seite 69, SMART.POINT ab Seite 74  
Order adapter separately: SMART.TRACK on page 69, SMART.POINT from page 74



# HUBBLE

Design: Böhler Design



## Strahler

Drehbar, schwenkbar  
Fokussierbarer Lichtaustritt 20-50°

Aluminium

Version SMART.TRACK

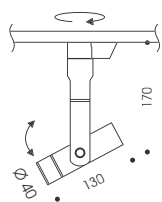

24 V DC 0,8 kg

Version SMART.POINT

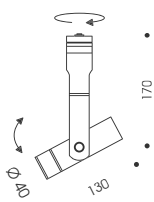

24 V DC 0,8 kg

## Spotlight

Rotatable, swiveling  
Focusable light emission 20-50°

Aluminium

LED | 900 lm | 10,5 W | 20-50° | CRI >90

Stange Rod	Version Version	2700 K	3000 K
Chrom matt Matt chrome	SMART.TRACK	22-872-20-06	22-872-30-06
	SMART.POINT	20-872-20-06	20-872-30-06
Weiß matt Matt white	SMART.TRACK	22-872-20-21	22-872-30-21
	SMART.POINT	20-872-20-21	20-872-30-21
Chrom Chrome	SMART.TRACK	22-872-20-23	22-872-30-23
	SMART.POINT	20-872-20-23	20-872-30-23

SMART.TRACK: Adapter integriert, SMART.POINT: Adapter separat bestellen ab Seite 74  
SMART.TRACK: integrated adapter, SMART.POINT: order adapter separately from page 74



# A LITTLE BIT



Chrom  
Chrome



Chrom matt  
Matt chrome

## Strahler

Drehbar, schwenkbar  
Fokussierbarer Lichtaustritt 20-60°

Aluminium, Glas

## Spotlight

Rotatable, swiveling  
Focusable light emission 20-60°

Aluminium, glass

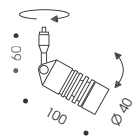

24 V DC 0,2 kg

LED | 650 lm | 8 W | 20-60° | CRI >90

Leuchte Luminaire	2700 K	3000 K
Chrom Chrome	20-898-40-05	20-898-50-05
Chrom matt Matt chrome	20-898-40-06	20-898-50-06

Adapter separat bestellen: SMART.TRACK auf Seite 69, SMART.POINT ab Seite 74  
Order adapter separately: SMART.TRACK on page 69, SMART.POINT from page 74

# A LITTLE BIT MORE

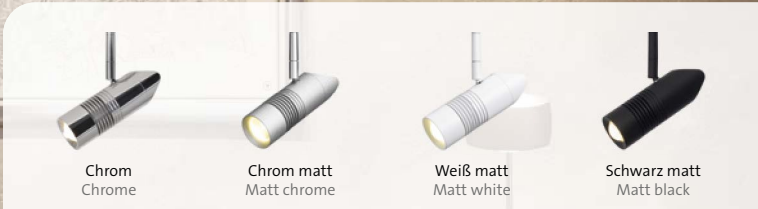

## Strahler

Drehbar, schwenkbar  
Fokussierbarer Lichtaustritt 20-60°

Aluminium, Glas

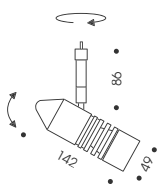

24 V DC    0,6 kg

## Spotlight

Rotatable, swiveling  
Focusable light emission 20-60°

Aluminium, glass

LED | 1200 lm | 11 W | 20-60° | CRI >90

Leuchte Luminaire	2700 K	3000 K
<b>Chrom</b> Chrome	20-882-41-05	20-882-51-05
<b>Chrom matt</b> Matt chrome	20-882-42-06	20-882-52-06
<b>Weiß matt</b> Matt white	20-882-43-21	20-882-53-21
<b>Schwarz matt</b> Matt black	20-882-40-23	20-882-50-23

Adapter separat bestellen: SMART.TRACK auf Seite 69, SMART.POINT ab Seite 74  
Order adapter separately: SMART.TRACK on page 69, SMART.POINT from page 74

# KELVEEN





SMARTHOM  
OPTION



**Strahler**

Drehbar, schwenkbar

KELVEEN Strahler können mit Filtern aus dichroitischem Glas ausgestattet werden. Es entsteht ein mehrfarbiges Lichtspiel.

Thermoplast, Aluminium, Glas

Spotlight

Rotatable, swiveling

KELVEEN spotlights can be equipped with dichroic glass filters. The result is a multicoloured play of light.

Thermoplastic, aluminium, glass

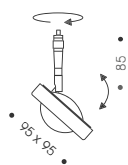

24 V DC 0,4 kg

LED | 1100 lm | 12,5 W | CRI >90

Leuchte Luminaire	Winkel Angle	2700 K	3000 K
<b>Chrom matt</b> Matt chrome	40°	20-869-20-06	20-869-30-06
	90°	20-869-21-06	20-869-31-06
<b>Weiß matt</b> Matt white	40°	20-869-20-21	20-869-30-21
	90°	20-869-21-21	20-869-31-21
<b>Schwarz matt</b> Matt black	40°	20-869-20-23	20-869-30-23
	90°	20-869-21-23	20-869-31-23

Adapter separat bestellen: SMART.TRACK auf Seite 69, SMART.POINT ab Seite 74  
Order adapter separately: SMART.TRACK on page 69, SMART.POINT from page 74

**OPTION: FILTER**

Farbe Colour	Artikel Item	Farbe Colour	Artikel Item
<b>Rot</b> Red	62-222-10-24	<b>Blau</b> Blue	62-222-10-37
<b>Gelb</b> Yellow	62-222-10-33	<b>Magenta</b> Magenta	62-222-10-46
<b>Grün</b> Green	62-222-10-35		

## 41 DEGREES

Design: Ottenwälder und Ottenwälder



Strahler

Drehbar, schwenkbar

Aluminium

Spotlight

Rotatable, swiveling

Aluminium

LED | 600 lm | 11 W | CRI &gt;85

Leuchte Luminaire	2700 K	3000 K
Chrom matt Matt chrome	20-871-10-06	20-871-11-06
Weiß matt Matt white	20-871-10-21	20-871-11-21
Schwarz matt Matt black	20-871-10-23	20-871-11-23

Adapter separat bestellen: SMART.TRACK auf Seite 69, SMART.POINT ab Seite 74  
 Order adapter separately: SMART.TRACK on page 69, SMART.POINT from page 74

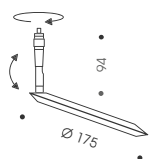

24 V DC 0,3 kg

# FLAVIA

Design: Ottenwalder und Ottenwalder



Chrom matt  
Matt chrome



Weiß matt  
Matt white



Schwarz matt  
Matt black



Geschlossen  
Closed



Transluzent  
Translucent

Raumlicht

Drehbar, schwenkbar  
Nicht dimmbar

Aluminium

Spotlight

Rotatable, swiveling  
Not dimmable

Aluminium

LED | 4,8 W | CRI >85

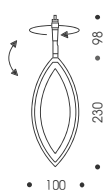

24 V DC 0,2 kg

Prismatik Prism	Lumen Lumen	Lichtfarbe Lightcolour	Chrom matt Matt chrome	Weiß matt Matt white	Schwarz matt Matt black
Offen Open	150	2700 K 3000 K	20-870-10-06 20-870-12-06	20-870-10-21 20-870-12-21	20-870-10-23 20-870-12-23
Geschlossen Closed	200	2700 K 3000 K	20-870-11-06 20-870-13-06	20-870-11-21 20-870-13-21	20-870-11-23 20-870-13-23
Transluzent Translucent	100	2700 K 3000 K	20-870-18-06 20-870-19-06	20-870-18-21 20-870-19-21	20-870-18-23 20-870-19-23

Adapter separat bestellen: SMART.TRACK auf Seite 69, SMART.POINT ab Seite 74  
Order adapter separately: SMART.TRACK on page 69, SMART.POINT from page 74

# GRACE

Design: Ralf Keferstein







GESTEN-  
STEUERUNG



CASAMBI  
ON BOARD



LICHTANTEILE  
UP / DOWN  
STEUERBAR



TUNABLE  
WHITE



MESH  
CONTROL

SMART.TRACK | SMART.POINT

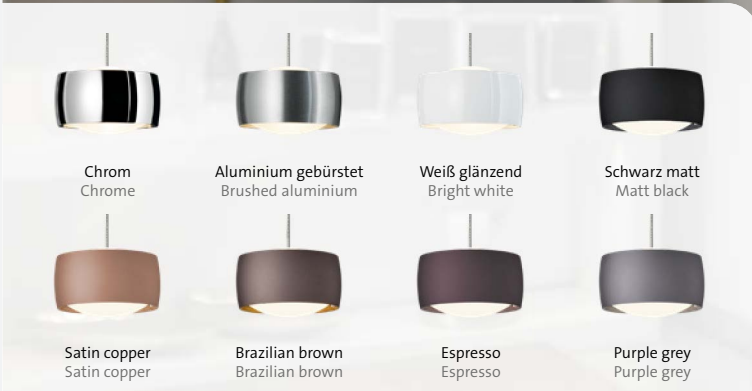

Pendelleuchte

Kürzbar

Abhängung auf Anfrage bis 5 m erhältlich  
Nicht über DALI steuerbar

Metall, Glas

Pendant luminaire

Can be shortened  
Suspension available up to 5 m on request  
Cannot be controlled via DALI

Metal, glass

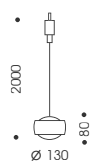

24 V DC 0,8 kg



LED | 2200-5000 K | 1150 lm | 22 W | CRI >90

Leuchte Luminaire	Artikel Item
Chrom Chrome	G20-931-41-05
Aluminium gebürstet Brushed aluminium	G20-931-41-12
Weiß glänzend Bright white	G20-931-41-20
Schwarz matt Matt black	G20-931-41-23
Satin copper Satin copper	G20-931-41-15
Brazilian brown Brazilian brown	G20-931-41-41
Espresso Espresso	G20-931-41-48
Purple grey Purple grey	G20-931-41-49

Adapter separat bestellen: SMART.TRACK auf Seite 69, SMART.POINT ab Seite 74  
Order adapter separately: SMART.TRACK on page 69, SMART.POINT from page 74

# RIO





SMARTHOME  
OPTION



**Pendelleuchte**

Nur kompatibel mit SMART.TRACK

Bitte die gewünschte Gesamtlänge angeben, bauseits nicht kürzbar  
Abhängung auf Anfrage bis 5 m erhältlich

Aluminium

Pendant luminaire

Only compatible with SMART.TRACK

Please state total length required, cannot be shortened on site  
Suspension available up to 5 m on request

Aluminium

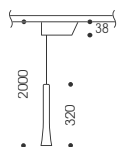

24 V DC | 300 mA 0,7 kg

LED | 2700 K | 1350 lm | 11,2 W | CRI >90

Kopf Head	Adapter: Adapter:	Chrom matt Matt chrome	Weiß matt Matt white	Schwarz matt Matt black
Pearl silver Pearl silver		22-861-10-06	22-861-20-06	22-861-30-06
Satin copper Satin copper		22-861-10-15	22-861-20-15	22-861-30-15
Atlantic blue Atlantic blue		22-861-10-38	22-861-20-38	22-861-30-38
Patagonia spring Patagonia spring		22-861-10-36	22-861-20-36	22-861-30-36
Red velvet Red velvet		22-861-10-25	22-861-20-25	22-861-30-25
Brazilian brown Brazilian brown		22-861-10-41	22-861-20-41	22-861-30-41
Espresso Espresso		22-861-10-48	22-861-20-48	22-861-30-48
Weiß matt Matt white		22-861-10-21	22-861-20-21	22-861-30-21
Schwarz matt Matt black		22-861-10-23	22-861-20-23	22-861-30-23

SMART.TRACK Adapter integriert  
Integrated SMART.TRACK adapter



GESTEN-  
STEUERUNG



CASAMBI  
ON BOARD



TUNABLE  
WHITE



MESH  
CONTROL

# DECENT



## Pendelleuchte

Kürzbar  
Abhängung auf Anfrage bis 5 m erhältlich  
Nicht über DALI steuerbar

Metall, Kunstglas



## Pendant luminaire

Can be shortened  
Suspension available up to 5 m on request  
Cannot be controlled via DALI

Metal, sythetic glass

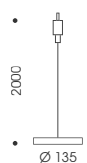

24 V DC 0,5 kg

LED | 2200-5000 K | 800 lm | 11 W | CRI >90

Leuchte Luminaire	Artikel
Chrom Chrome	G20-885-12-05
Aluminium gebürstet Brushed aluminium	G20-885-12-12
Weiß matt Matt white	G20-885-12-21

Adapter separat bestellen: SMART.TRACK auf Seite 69, SMART.POINT ab Seite 74  
Order adapter separately: SMART.TRACK on page 69, SMART.POINT from page 74

# BALINO



## Pendelleuchte

Nur kompatibel mit SMART.TRACK  
Bitte die gewünschte Gesamtlänge angeben, bauseits nicht kürzbar  
Abhängung auf Anfrage bis 5 m erhältlich

Metall, Glas

## Pendant luminaire

Only compatible with SMART.TRACK  
Please state total length required, cannot be shortened on site  
Suspension available up to 5 m on request

Metal, glass

LED | 2700 K | 1050 lm | 11,2 W | CRI >90

Haube Cap	Schirm Shade	Adapter: Adapter:	Chrom matt Matt chrome	Weiß matt Matt white	Schwarz matt Matt black
Chrom Chrome	Satiniert Satin			22-880-20-05/03	22-880-30-05/03
	Diamantgrau glänzend Bright diamond grey			22-880-20-05/44	22-880-30-05/44
	Orange glänzend Bright orange			22-880-20-05/29	22-880-30-05/29
Chrom matt Matt chrome	Satiniert Satin	22-880-10-06/03		22-880-20-06/03	22-880-30-06/03
	Tabak glänzend Bright tobacco	22-880-10-06/40		22-880-20-06/40	22-880-30-06/40
	Gold glänzend Bright gold	22-880-10-06/08		22-880-20-06/08	22-880-30-06/08

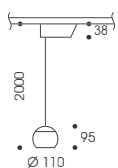

24 V DC | 300 mA 0,5 kg

SMART.TRACK Adapter integriert  
Integrated SMART.TRACK adapter

## A LITTLE BIT





**Pendelleuchte**

Bitte die gewünschte Gesamtlänge angeben, bauseits nicht kürzbar  
 Abhängung auf Anfrage bis 5 m erhältlich  
 Fokussierbarer Lichtaustritt 20-60°

Bei Einbindung der Leuchte in eine Smarthome Steuerung wird die Funktion des Dimmtasters deaktiviert

Aluminium, Glas

**Pendant luminaire**

Please state total length required, cannot be shortened on site  
 Suspension available up to 5 m on request  
 Focusable light emission 20-60°

When the luminaire is integrated into a smarthome control system, the function of the dimmer switch is deactivated

Aluminium, glass

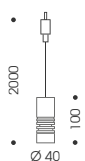

24 V DC 0,2 kg

LED | 650 lm | 8 W | 20-60° | CRI >90

Leuchte Luminaire	2700 K	3000 K
Chrom Chrome	20-898-20-05	20-898-30-05
Chrom matt Matt chrome	20-898-20-06	20-898-30-06

Adapter separat bestellen: SMART.TRACK auf Seite 69, SMART.POINT ab Seite 74  
 Order adapter separately: SMART.TRACK on page 69, SMART.POINT from page 74







## SLACK-LINE FÜR SMART.TRACK

Exklusiv-Sortiment: Bezug nur über ausgewählte Fachhändler

Exclusive range: Purchase only via selected dealers

„Am Anfang stand eine einfache Schlaufe, am Ende ein hochvariables System“ - dieser Satz fasst die Entwicklung von SLACK-LINE treffend zusammen. Denn das Konzept der exklusiven und modularen Einzelleuchterserie basiert auf der innovativen Idee, verschiedenste Lichtmodule in eine oder mehrere Seilschlaufen einzuhängen und beliebig kombinieren zu können. Ganz gleich, ob Ambiente- oder Arbeitsplatzbeleuchtung, direktes oder indirektes Licht, Punkt- oder Flächenlicht.

Dank der neuen Adapter stehen das exklusive SLACK-LINE Konzept und die dazugehörigen Lichtmodule nun auch für das SMART.TRACK Schienensystem zur Verfügung. Die Seilschlaufen können je nach Adaptervariante längs oder quer zum Schienenverlauf angebracht werden.

Harmonisch ausgewählte Farbtöne, gepaart mit einer zart-schimmernden Oberfläche, laden ein zur Variation der Module. Doch die Flexibilität geht noch weiter: Farbe und Intensität des Lichts lassen sich ohne weiteres Zubehör per Funk steuern, wahlweise jedes Modul allein, mehrere Module in einer Gruppe oder auch gemeinsam mit weiteren Leuchten.

SLACK-LINE bietet eine innovative Lichterfahrung mit allen Sinnen. Tauchen Sie ein in die neue Welt des Lichts.

“In the beginning there was a simple loop, in the end a highly variable system“ - this sentence aptly sums up the development of SLACK-LINE. Because the concept of the exclusive and modular lighting system is based on the innovative idea of hooking the respective light modules into a rope loop and thus being able to combine them as required. No matter whether ambient or workplace lighting, direct or indirect light, point or area light.

With the new adapters, the exclusive SLACK-LINE concept and the corresponding light modules are now also available for the SMART.TRACK track system. The cable loops can be attached lengthwise or crosswise to the track, depending on the adapter variant.

Harmoniously selected colour shades, paired with a delicately shimmering finish, invite you to vary the modules. But the flexibility goes even further: the colour and intensity of the light can be controlled by wireless control without any additional accessories, either each module alone, several modules in a group or together with other luminaires.

SLACK-LINE offers an innovative lighting experience for all the senses. Immerse yourself in the new world of light.



# CURVED

Exklusiv-Sortiment: Bezug nur über ausgewählte Fachhändler  
 Exclusive range: Purchase only via selected dealers

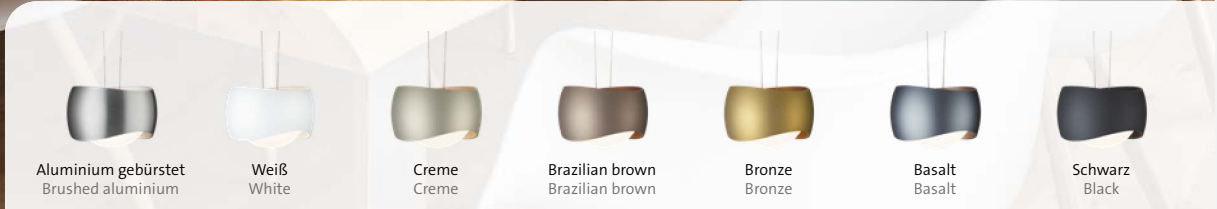

## Lichtmodul für Seilschlaufen

Nur kompatibel mit SMART.TRACK  
 Abhängung kürzbar, auf Anfrage bis 5 m erhältlich

Aluminium, Glas

Light module for cable loops

Only compatible with SMART.TRACK  
 Suspension can be shortened, available up to 5 m on request

Aluminium, glass



24 V DC 1,1 kg

LED | 2200-5000 K | 1250 lm | 20 W | CRI >90

Leuchte Luminaire	Artikel Item
Aluminium gebürstet Brushed aluminium	G71-845-10-12
Weiß matt White	G71-845-10-21
Creme Creme	G71-845-10-19
Brazilian brown Brazilian brown	G71-845-10-41
Bronze Bronze	G71-845-10-17
Basalt Basalt	G71-845-10-18
Schwarz matt Black	G71-845-10-23

SMART.TRACK Adapter Schlaufe längs oder Schlaufe quer separat bestellen auf Seite 69  
 Order SMART.TRACK loop adapter lengthwise or crosswise separately on page 69



BERÜHRUNGS-  
DIMMER



CASAMBI  
ON BOARD



TUNABLE  
WHITE



MESH  
CONTROL

SMART.TRACK | SMART.POINT

# GLOBE

Exklusiv-Sortiment: Bezug nur über ausgewählte Fachhändler  
Exclusive range: Purchase only via selected dealers



Weiß | Weiß  
White | White



Weiß | Roségold  
White | Rose gold



Basalt | Creme  
Basalt | Creme



Basalt | Bronze  
Basalt | Bronze



Schwarz | Schwarz  
Black | Black



Schwarz | Creme  
Black | Creme



Schwarz | Bronze  
Black | Bronze



Schwarz | Roségold  
Black | Rose gold

Lichtmodul für Seilschlaufen

Nur kompatibel mit SMART.TRACK  
Abhängung kürzbar, auf Anfrage bis 5 m erhältlich

Aluminium, Glas

Light module for cable loops

Only compatible with SMART.TRACK  
Suspension can be shortened, available up to 5 m on request

Aluminium, glass

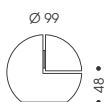

24 V DC 1,0 kg

LED | 2200-5000 K | 1000 lm | 12,8 W | CRI >90

Primärfarbe Main colour	Sekundärfarbe Secondary colour	Artikel Item
Weiß White	Weiß White	T71-848-10-21/21
	Roségold Rose gold	T71-848-10-21/16
Basalt Basalt	Creme Creme	T71-848-10-18/19
	Bronze Bronze	T71-848-10-18/17
Schwarz Black	Schwarz Black	T71-848-10-23/23
	Creme Creme	T71-848-10-23/19
	Bronze Bronze	T71-848-10-23/17
	Roségold Rose gold	T71-848-10-23/16

SMART.TRACK Adapter Schlaufe längs oder Schlaufe quer separat bestellen auf Seite 69  
Order SMART.TRACK loop adapter lengthwise or crosswise separately on page 69

# NABO

Exklusiv-Sortiment: Bezug nur über ausgewählte Fachhändler  
 Exclusive range: Purchase only via selected dealers



Weiß | Weiß  
White | White

Weiß | Roségold  
White | Rose gold

Basalt | Creme  
Basalt | Creme

Basalt | Bronze  
Basalt | Bronze

Schwarz | Schwarz  
Black | Black

Schwarz | Creme  
Black | Creme

Schwarz | Bronze  
Black | Bronze

Schwarz | Roségold  
Black | Rose gold

### Lichtmodul für Seilschlaufen

Nur kompatibel mit SMART.TRACK  
 Abhängung kürzbar, auf Anfrage bis 5 m erhältlich

Aluminium, Glas

### Light module for cable loops

Only compatible with SMART.TRACK  
 Suspension can be shortened, available up to 5 m on request

Aluminium, glass

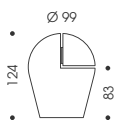

24 V DC 1,1 kg

LED | 2200-5000 K | 1000 lm | 12,8 W | CRI >90

Primärfarbe Main colour	Sekundärfarbe Secondary colour	Artikel Item
Weiß White	Weiß White	T71-847-10-21/21
	Roségold Rose gold	T71-847-10-21/16
Basalt Basalt	Creme Creme	T71-847-10-18/19
	Bronze Bronze	T71-847-10-18/17
Schwarz Black	Schwarz Black	T71-847-10-23/23
	Creme Creme	T71-847-10-23/19
	Bronze Bronze	T71-847-10-23/17
	Roségold Rose gold	T71-847-10-23/16

SMART.TRACK Adapter Schlaufe längs oder Schlaufe quer separat bestellen auf Seite 69  
 Order SMART.TRACK loop adapter lengthwise or crosswise separately on page 69

# CONE

Exklusiv-Sortiment: Bezug nur über ausgewählte Fachhändler  
 Exclusive range: Purchase only via selected dealers



Weiß | Weiß  
White | White

Weiß | Roségold  
White | Rose gold

Basalt | Creme  
Basalt | Creme

Basalt | Bronze  
Basalt | Bronze

Schwarz | Schwarz  
Black | Black

Schwarz | Creme  
Black | Creme

Schwarz | Bronze  
Black | Bronze

Schwarz | Roségold  
Black | Rose gold

## Lichtmodul für Seilschlaufen

Nur kompatibel mit SMART.TRACK  
 Abhängung kürzbar, auf Anfrage bis 5 m erhältlich

Aluminium, Glas

## Light module for cable loops

Only compatible with SMART.TRACK  
 Suspension can be shortened, available up to 5 m on request  
 Aluminium, glass

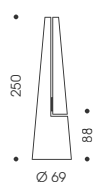

24 V DC 0,8 kg

LED | 2200-5000 K | 1000 lm | 12,8 W | CRI >90

Primärfarbe Main colour	Sekundärfarbe Secondary colour	Artikel Item
Weiß White	Weiß White	T71-846-10-21/21
	Roségold Rose gold	T71-846-10-21/16
Basalt Basalt	Creme Creme	T71-846-10-18/19
	Bronze Bronze	T71-846-10-18/17
Schwarz Black	Schwarz Black	T71-846-10-23/23
	Creme Creme	T71-846-10-23/19
	Bronze Bronze	T71-846-10-23/17
	Roségold Rose gold	T71-846-10-23/16

SMART.TRACK Adapter Schlaufe längs oder Schlaufe quer separat bestellen auf Seite 69  
 Order SMART.TRACK loop adapter lengthwise or crosswise separately on page 69

# BREAK-IT

Design: HYVE, OLIGO



## MIX & MATCH



Roségold | Schwarz  
Rose gold | Black



Bronze | Schwarz  
Bronze | Black



Basalt | Basalt  
Basalt | Basalt



Crème | Basalt  
Crème | Basalt



Weiß | Weiß  
White | White

Exklusiv-Sortiment: Bezug nur über ausgewählte Fachhändler  
 Exclusive range: Purchase only via selected dealers



Lichtmodul für Seilschlaufen

Nur kompatibel mit SMART.TRACK  
 Abhängung kürzbar, auf Anfrage bis 5 m erhältlich  
 Magnetisch: Je zwei Break-It lassen sich am unteren Ende verbinden  
 Lagesensor: Leuchte wechselt automatisch zwischen Punktlicht (vertikal) und Flächenlicht (horizontal)

Aluminium, Kunstglas

**DESIGN PLUS**  
 Best of 2020



24 V DC 0,6 kg

Light module for cable loops

Only compatible with SMART.TRACK  
 Suspension can be shortened, available up to 5 m on request  
 Magnetic: Two Break-It can be connected to each other at the lower end  
 Position sensor: Luminaire automatically switches between vertical point light and horizontal area light

Aluminium, synthetic glass

LED | 2200-5000 K | CRI >90  
 Horizontal: 600 lm | 10,3 W | Vertikal: 550 lm | 8,8 W

Leuchte Luminaire	Artikel Item	Leuchte Luminaire	Artikel Item
Weiß White	71-850-11-21	Schwarz Black	71-850-11-23
Creme Creme	71-850-11-19	Bronze Bronze	71-850-11-17
Basalt Basalt	71-850-11-18	Roségold Rose gold	71-850-11-16

SMART.TRACK Adapter Schlaufe längs separat bestellen auf Seite 69  
 Order SMART.TRACK loop adapter lengthwise separately on page 69

# KENDO S

Exklusiv-Sortiment: Bezug nur über ausgewählte Fachhändler  
Exclusive range: Purchase only via selected dealers



## Lichtmodul für Seilschlaufen

Nur kompatibel mit SMART.TRACK  
Abhängung kürzbar, auf Anfrage bis 5 m erhältlich  
Lineare Fresnellinse (UGR <19) für optimale Entblendung  
Für indirektes Licht kann KENDO um 180° gedreht werden

Aluminium, Glas

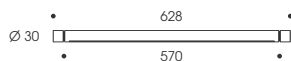

24 V DC 1,0 kg

## Light module for cable loops

Only compatible with SMART.TRACK  
Suspension can be shortened, available up to 5 m on request  
Linear Fresnel lens (UGR <19) for optimal glare control  
If indirect illumination is desired, KENDO can be rotated by 180°

Aluminium, glass

LED | 2200-5000 K | 1300 lm | 13,6 W | CRI >90

Leuchte Luminaire	Artikel Item	Leuchte Luminaire	Artikel Item
Weiß White	G71-851-10-21	Basalt Basalt	G71-851-10-18
Creme Creme	G71-851-10-19	Schwarz Black	G71-851-10-23

SMART.TRACK Adapter Schlaufe quer separat bestellen auf Seite 69  
Order SMART.TRACK loop adapter crosswise separately on page 69





GESTEN-  
STEUERUNG



CASAMBI  
ON BOARD



TUNABLE  
WHITE



MESH  
CONTROL

SMART.TRACK | SMART.POINT

# KENDO M

Exklusiv-Sortiment: Bezug nur über ausgewählte Fachhändler  
Exclusive range: Purchase only via selected dealers



Weiß  
White

Crème  
Crème

Basalt  
Basalt

Schwarz  
Black

## Lichtmodul für Seilschlaufen

Nur kompatibel mit SMART.TRACK  
Abhängung kürzbar, auf Anfrage bis 5 m erhältlich  
Lineare Fresnellinse (UGR <19) für optimale Entblendung  
Für indirektes Licht kann KENDO um 180° gedreht werden

Aluminium, Glas

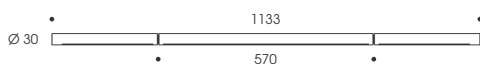

24 V DC 1,1 kg

## Light module for cable loops

Only compatible with SMART.TRACK  
Suspension can be shortened, available up to 5 m on request  
Linear Fresnel lens (UGR <19) for optimal glare control  
If indirect illumination is desired, KENDO can be rotated by 180°

Aluminium, glass

LED | 2200-5000 K | 2400 lm | 26,5 W | CRI >90

Leuchte Luminaire	Artikel Item	Leuchte Luminaire	Artikel Item
Weiß White	G71-851-20-21	Basalt Basalt	G71-851-20-18
Crème Crème	G71-851-20-19	Schwarz Black	G71-851-20-23

SMART.TRACK Adapter Schlaufe quer separat bestellen auf Seite 69  
Order SMART.TRACK loop adapter crosswise separately on page 69

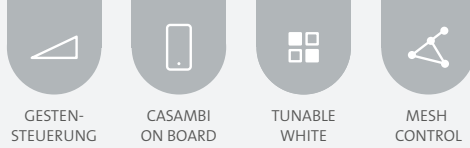

# KENDO L

Exklusiv-Sortiment: Bezug nur über ausgewählte Fachhändler  
 Exclusive range: Purchase only via selected dealers



### Lichtmodul für Seilschlaufen

Nur kompatibel mit SMART.TRACK  
 Abhängung kürzbar, auf Anfrage bis 5 m erhältlich  
 Lineare Fresnellinse (UGR <19) für optimale Entblendung  
 Für indirektes Licht kann KENDO um 180° gedreht werden

Aluminium, Glas



### Light module for cable loops

Only compatible with SMART.TRACK  
 Suspension can be shortened, available up to 5 m on request  
 Linear Fresnel lens (UGR <19) for optimal glare control  
 If indirect illumination is desired, KENDO can be rotated by 180°

Aluminium, glass

LED | 2200-5000 K | 3200 lm | 40,5 W | CRI >90

Leuchte Luminaire	Artikel Item	Leuchte Luminaire	Artikel Item
Weiß White	G71-851-30-21	Basalt Basalt	G71-851-30-18
Creme Creme	G71-851-30-19	Schwarz Black	G71-851-30-23

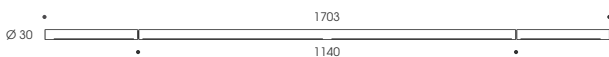

24 V DC 1,6 kg

SMART.TRACK Adapter Schlaufe quer separat bestellen auf Seite 69  
 Order SMART.TRACK loop adapter crosswise separately on page 69



BERÜHRUNGS-  
DIMMER



CASAMBI  
ON BOARD



TUNABLE  
WHITE



MESH  
CONTROL

SMART.TRACK | SMART.POINT

# NOVA S | NOVA M

Exklusiv-Sortiment: Bezug nur über ausgewählte Fachhändler  
Exclusive range: Purchase only via selected dealers

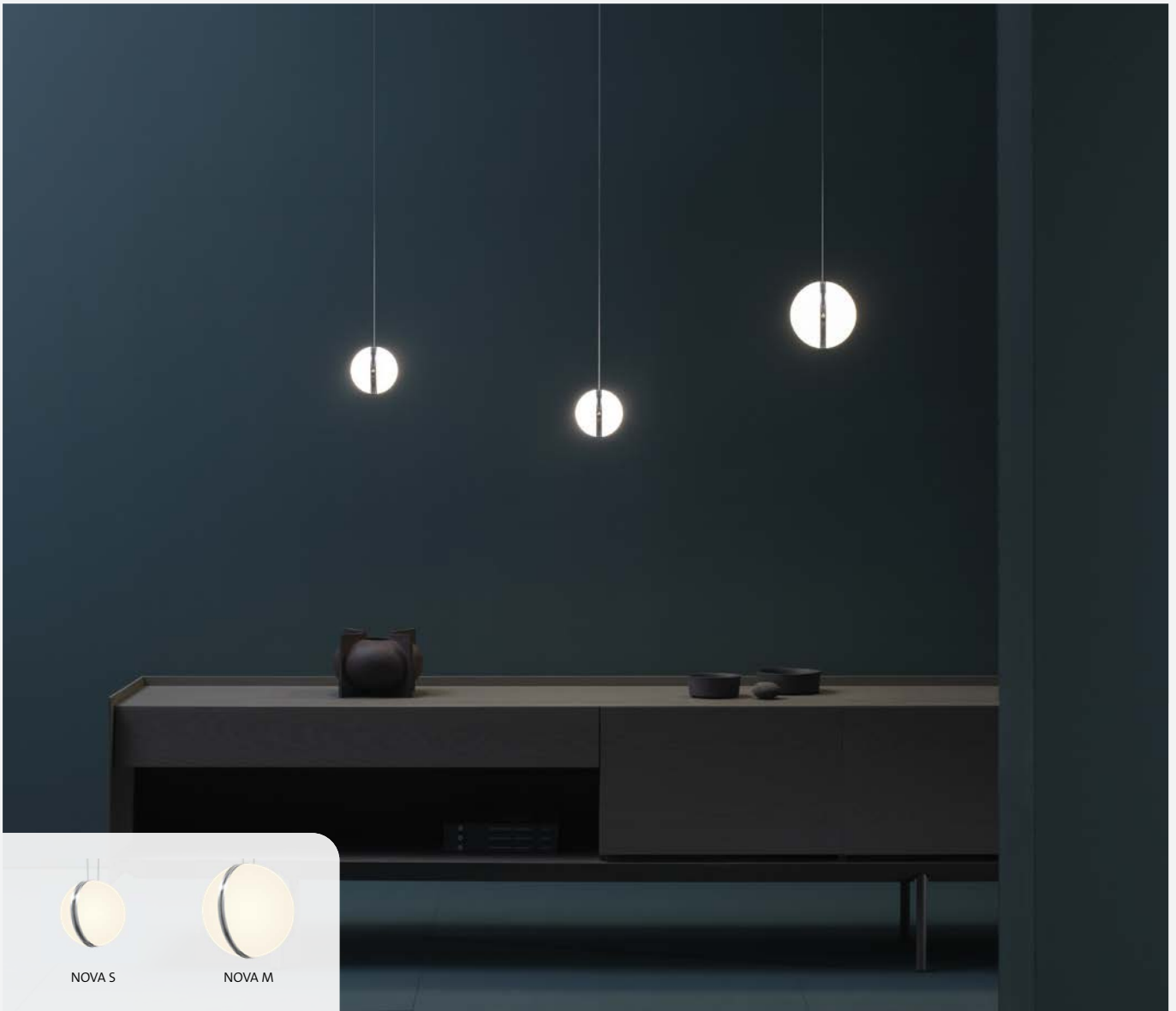

NOVA S



NOVA M

Lichtmodul für Seilschlaufen

Nur kompatibel mit SMART.TRACK  
Abhängung kürzbar, auf Anfrage bis 5 m erhältlich

Handgefertigtes opalisiertes Kristallglas, Aluminium

Light module for cable loops

Only compatible with SMART.TRACK  
Suspension can be shortened, available up to 5 m on request

Handmade opalised crystal glass, aluminium

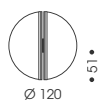

24 V DC 0,8 kg

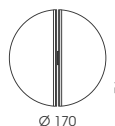

24 V DC 1,3 kg

NOVA S: LED | 2200-5000 K | 350 lm | 10 W | CRI >90  
NOVA M: LED | 2200-5000 K | 500 lm | 13,8 W | CRI >90

Typ	Type	Größe	Size	Artikel	Item
NOVA S		Ø 120 mm		T71-849-10-21	
NOVA M		Ø 170 mm		T71-849-20-21	

SMART.TRACK Adapter Schlaufe längs oder Schlaufe quer separat bestellen auf Seite 69  
Order SMART.TRACK loop adapter lengthwise or crosswise separately on page 69

# SMART.TRACK SYSTEMKOMPONENTEN SYSTEM COMPONENTS

24 V | max. 10 A

Die Komponenten eines Schienensystems variieren je nach Anwendungssituation und individuellen Anforderungen des Kunden. Ein funktionsfähiges System besteht immer aus bestimmten Basiskomponenten.

Die nachfolgende Checkliste erleichtert die Prüfung zur Vollständigkeit des Systems und dient als Leitfaden für die richtige Auswahl der Komponenten.

Beispiele Examples

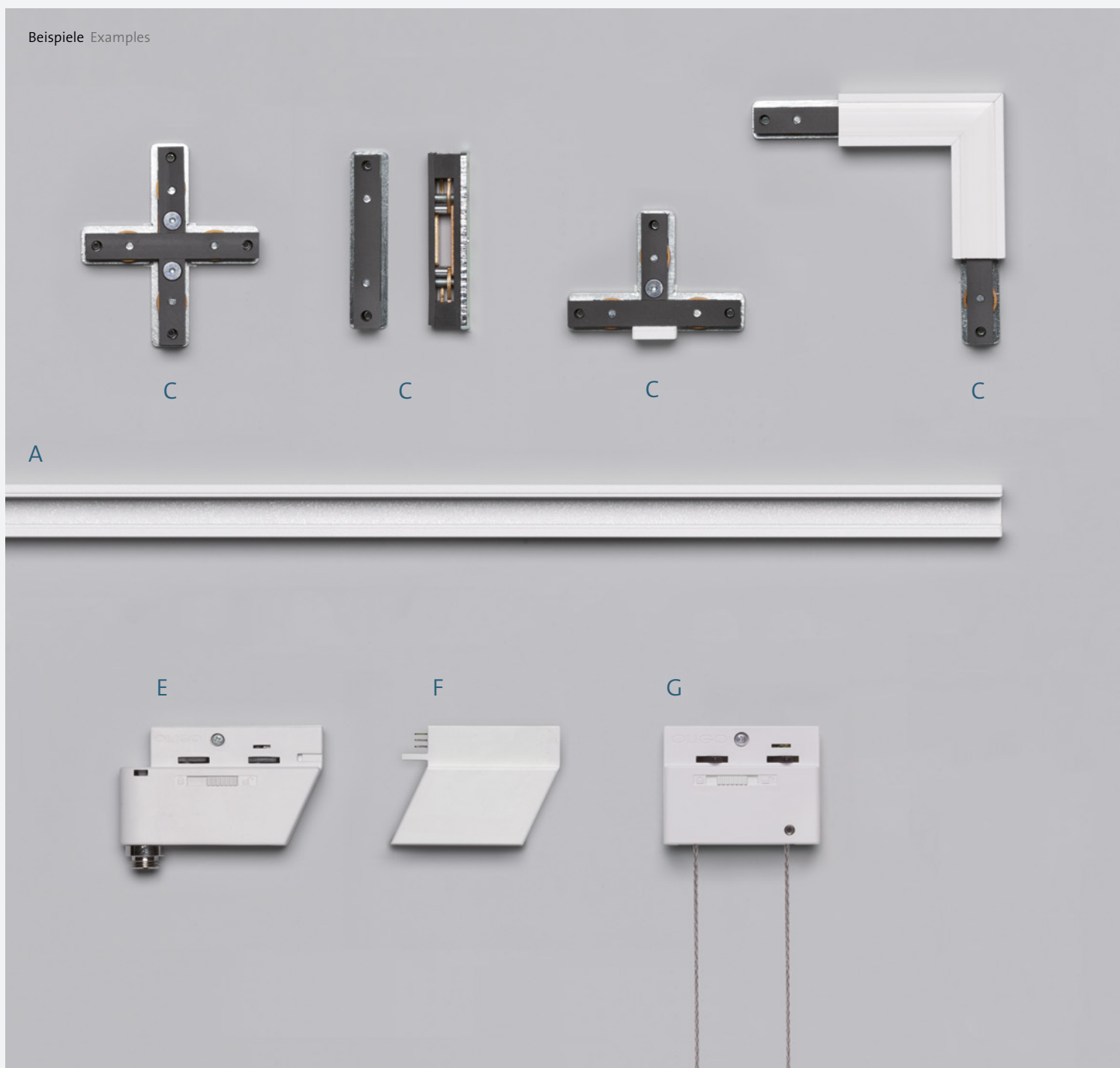

The components of a rail system vary depending on the application situation and the individual requirements of the customer. A functional system always consists of certain basic components.

The following checklist facilitates the check for the completeness of the system and serves as a guide for the correct selection of components.

B



D



C



### CHECKLISTE BASISKOMPONENTEN CHECKLIST BASIC COMPONENTS

- A **Stromschiene**  
Track
- B **Träger**  
Support
- C **Kupplung**  
Connector
- D **Einspeisung**  
Power supply  
**Endkappen**  
End cap
- E **Adapter mit Steckkontaktbuchse**  
Adapter with plug contact socket
- F **SMART.IQ Funkadapter**  
Luminaire adapter
- G **Adapter mit Seilschlaufe**  
Adapter with cable loop  
**Netzteil, systemseitig oder extern**  
Power supply unit, system-side or external

### DISTANZEN UND GEWICHTE DISTANCES AND WEIGHTS

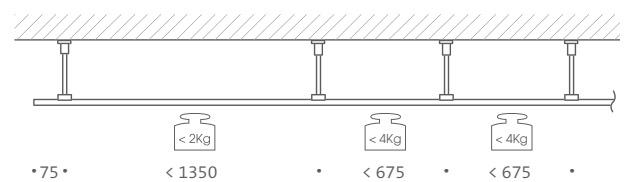

# SMART.TRACK

## INSTALLATIONSBEISPIEL INSTALLATION EXAMPLE

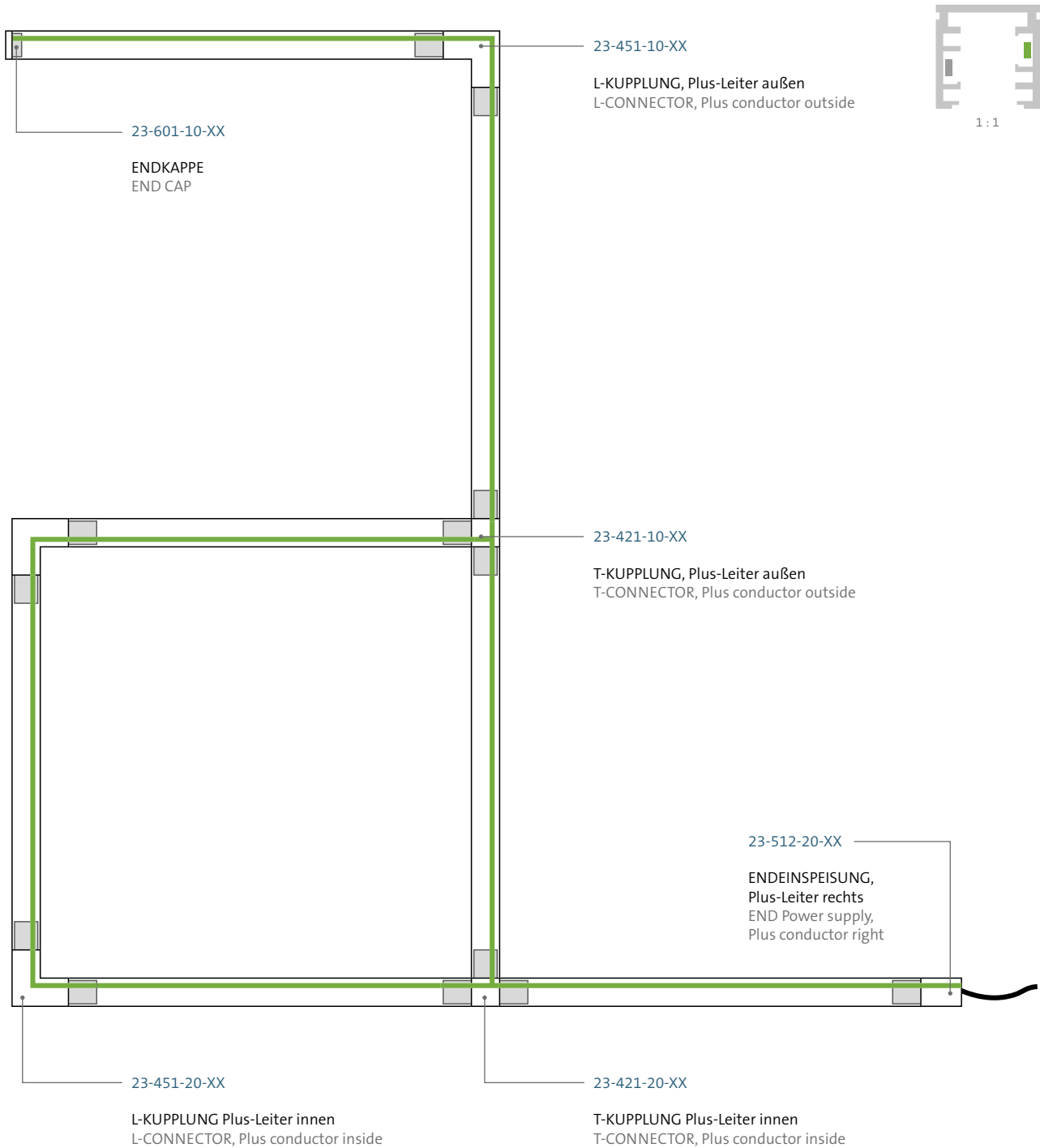

**Plus-Leiter 24 V DC.** Bei der Auswahl von Einspeisung, L- und T-Kupplungen ist auf eine durchgehende Plusleiterführung zu achten.  
Positive conductor 24 V DC. When selecting power supply, L and T couplings, ensure that the positive conductor is continuous.

# SMART.TRACK

## LEUCHTENADAPTER LUMINAIRE ADAPTERS

24 V DC | max. 2 A

Die kompakten Adapter sind frei auf der SMART.TRACK Schiene positionierbar und schnell montierbar. Sie werden einfach durch mechanische Verriegelung mit dem Schienensystem verbunden. Ein integrierter Verdrehschutz sorgt für Installationssicherheit.

The compact adapters can be freely positioned on the SMART.TRACK rail and quickly mounted. They are simply connected to the track system by mechanical locking. An integrated anti-twist protection ensures installation safety.

### 1.1 BUCHSE SOCKET



Zur Adaption von Leuchten mit SMART.POINT Stecker an die SMART.TRACK Schiene

SMART.POINT Buchse integriert

Metall, Kunststoff

Erweiterbar mit SMART.IQ Funkmodul zur digitalen Lichtsteuerung über Casambi oder Homematic, siehe Seite 77.

For adapting luminaires with SMART.POINT plug to the SMART.TRACK track

SMART.POINT socket integrated

Metal, plastic

Can be expanded with SMART.IQ radio module for digital lighting control via Casambi or Homematic, see page 77.

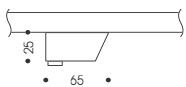

### 1.2 SCHLAUFE LÄNGS LENGTHWISE CABLE LOOP



Zur Adaption von Lichtmodulen für Seilschlaufen an die SMART.TRACK Schiene, Ausrichtung längs, nicht kompatibel mit KENDO

Inklusive 2 m Abhängung, kürzbar  
Abhängung auf Anfrage bis 5 m erhältlich

Exklusiv-Sortiment: Bezug nur über ausgewählte Fachhändler

Metall, Kunststoff

For adapting light module for cable loops to the SMART.TRACK track, longitudinal alignment, not compatible with KENDO

Includes 2 m suspension, can be shortened  
Suspension available up to 5 m on request

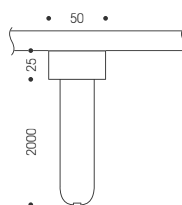

Exclusive range:  
Purchase only via  
selected dealers

Metal, plastic

### 1.3 SCHLAUFE QUER CROSSWISE CABLE LOOP



Zur Adaption von Lichtmodulen für Seilschlaufen an die SMART.TRACK Schiene, Ausrichtung quer, nicht kompatibel mit BREAK-IT

Inklusive 2 m Abhängung, kürzbar  
Abhängung auf Anfrage bis 5 m erhältlich

Exklusiv-Sortiment: Bezug nur über ausgewählte Fachhändler

Metall, Kunststoff

For adapting light module for cable loops to the SMART.TRACK track, transverse alignment, not compatible with BREAK-IT

Includes 2 m suspension, can be shortened  
Suspension available up to 5 m on request

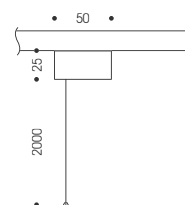

Exclusive range:  
Purchase only via  
selected dealers

Metal, plastic

Farbe Colour	Artikel Item
Chrom matt Matt chrome	23-623-10-06
Weiß matt Matt white	23-623-10-21
Schwarz matt Matt black	23-623-10-23

Farbe Colour	Artikel Item
Chrom matt Matt chrome	23-627-10-06
Weiß matt Matt white	23-627-10-21
Schwarz matt Matt black	23-627-10-23

Farbe Colour	Artikel Item
Chrom matt Matt chrome	23-627-11-06
Weiß matt Matt white	23-627-11-21
Schwarz matt Matt black	23-627-11-23

# SMART.TRACK

## 2.1 SCHIENE TRACK



17 x 17 mm / Leiterquerschnitt 2x 4,05 mm<sup>2</sup>, kürzbar  
Version Schiene gelocht für deckenbündige Montage ohne Träger  
Metall

17 x 17 mm / conductor cross-section 2x 4.05 mm<sup>2</sup>, can be shortened  
Version punched track for mounting flush with ceiling without support  
Metal

### SCHIENE TRACK

Farbe Colour	L (mm)	Artikel Item
Chrom matt Matt chrome	500	23-201-10-06
Weiß matt Matt white	500	23-201-10-21
Schwarz matt Matt black	500	23-201-10-23
Chrom matt Matt chrome	1500	23-201-12-06
Weiß matt Matt white	1500	23-201-12-21
Schwarz matt Matt black	1500	23-201-12-23

### SCHIENE GELOCHT PUNCHED TRACK

Farbe Colour	L (mm)	Artikel Item
Chrom matt Matt chrome	500	23-201-20-06
Weiß matt Matt white	500	23-201-20-21
Schwarz matt Matt black	500	23-201-20-23
Chrom matt Matt chrome	1500	23-201-22-06
Weiß matt Matt white	1500	23-201-22-21
Schwarz matt Matt black	1500	23-201-22-23

## 2.2 ABDECKPROFIL COVER PROFILE



Optionales Zubehör, kürzbar  
Kunststoff

Optional accessory, can be shortened  
Plastic

## 3. TRÄGER SUPPORT



Kürzbar  
Metall  
Can be shortened  
Metal

Farbe	Colour	Artikel Item
Chrom matt	Matt chrome	23-301-10-06
Weiß matt	Matt white	23-301-10-21
Schwarz matt	Matt black	23-301-10-23

## 4.1 I-KUPPLUNG I-CONNECTOR



Metall, Kunststoff  
Metal, Plastic

Typ	Type	Artikel Item
Leitend	Conductive	23-401-10-00
Isolierend	Insulating	23-401-20-00

## 4.2 L-KUPPLUNG L-CONNECTOR



Metall, Kunststoff  
Metal, Plastic

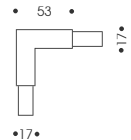

### PLUS-LEITER AUSSEN PLUS COND. OUTSIDE

Farbe	Colour	Artikel Item
Chrom matt	Matt chrome	23-451-10-06
Weiß matt	Matt white	23-451-10-21
Schwarz matt	Matt black	23-451-10-23

### PLUS-LEITER INNEN PLUS COND. INSIDE

Farbe	Colour	Artikel Item
Chrom matt	Matt chrome	23-451-20-06
Weiß matt	Matt white	23-451-20-21
Schwarz matt	Matt black	23-451-20-23



4.3 T-KUPPLUNG  
T-CONNECTOR



Metall, Kunststoff  
Metal, Plastic

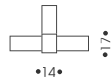

PLUS-LEITER AUSSEN PLUS COND. OUTSIDE

Farbe	Colour	Artikel	Item
Chrom matt	Matt chrome	23-421-10-06	
Weiß matt	Matt white	23-421-10-21	
Schwarz matt	Matt black	23-421-10-23	

PLUS-LEITER INNEN PLUS COND. INSIDE

Farbe	Colour	Artikel	Item
Chrom matt	Matt chrome	23-421-20-06	
Weiß matt	Matt white	23-421-20-21	
Schwarz matt	Matt black	23-421-20-23	

4.4 X-KUPPLUNG  
X-CONNECTOR



Metall, Kunststoff  
Metal, Plastic

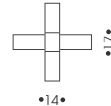

Farbe	Colour	Artikel	Item
Chrom matt	Matt chrome	23-431-10-06	
Weiß matt	Matt white	23-431-10-21	
Schwarz matt	Matt black	23-431-10-23	

4.5 FLEKKUPPLUNG  
FLEXIBLE CONNECTOR



150 mm  
2x 2,5 mm<sup>2</sup>

Metall, Kunststoff  
Metal, Plastic

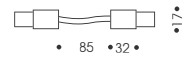

Farbe	Colour	Artikel	Item
Chrom matt	Matt chrome	23-461-10-06	
Weiß matt	Matt white	23-461-10-21	
Schwarz matt	Matt black	23-461-10-23	

5.1 ENDEINSPEISUNG  
END POWER SUPPLY



500 mm  
2x 2,5 mm<sup>2</sup>

Metall, Kunststoff  
Metal, Plastic

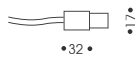

PLUS-LEITER LINKS PLUS CONDUCTOR LEFT

Farbe	Colour	Artikel	Item
Chrom matt	Matt chrome	23-512-10-06	
Weiß matt	Matt white	23-512-10-21	
Schwarz matt	Matt black	23-512-10-23	

PLUS-LEITER RECHTS PLUS COND. RIGHT

Farbe	Colour	Artikel	Item
Chrom matt	Matt chrome	23-512-20-06	
Weiß matt	Matt white	23-512-20-21	
Schwarz matt	Matt black	23-512-20-23	

5.2 ENDEINSPEISUNG, FLEKKABEL  
END POWER SUPPLY, FLEXIBLE CABLE



500 mm  
2x 2,5 mm<sup>2</sup>

Metall, Kunststoff  
Metal, Plastic

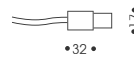

PLUS-LEITER LINKS PLUS CONDUCTOR LEFT

Farbe	Colour	Artikel	Item
Chrom matt	Matt chrome	23-512-40-06	
Weiß matt	Matt white	23-512-40-21	
Schwarz matt	Matt black	23-512-40-23	

PLUS-LEITER RECHTS PLUS COND. RIGHT

Farbe	Colour	Artikel	Item
Chrom matt	Matt chrome	23-512-50-06	
Weiß matt	Matt white	23-512-50-21	
Schwarz matt	Matt black	23-512-50-23	

5.3 MITTELSPEISUNG  
CENTRE POWER SUPPLY



500 mm  
2x 2,5 mm<sup>2</sup>

Nur in Kombination mit  
Trägern ≥100 mm oder  
abgehängten Decken  
Metall, Kunststoff

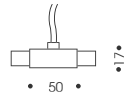

Only in combination with beams ≥100 mm or suspended ceilings  
Metal, Plastic

Farbe	Colour	Artikel	Item
Chrom matt	Matt chrome	23-512-30-06	
Weiß matt	Matt white	23-512-30-21	
Schwarz matt	Matt black	23-512-30-23	

## SMART.TRACK

### 5.4 ABDECKPLATTE COVER PLATE



Ø 100 mm

Für End- und Mitteleinspeisung  
Einbauöffnung 18-40 mm  
Metall

For end and centre power supply  
Installation opening 18-40 mm  
Metal

Farbe	Colour	Artikel Item
Weiß matt	Matt white	23-661-10-21

### 6. ENDKAPPE END CAP



17 x 17 x 8,5 mm

Kunststoff  
Plastic

Farbe	Colour	Artikel Item
Chrom matt	Matt chrome	23-601-10-06
Weiß matt	Matt white	23-601-10-21
Schwarz matt	Matt black	23-601-10-23

## GLEICHSPANNUNGSNETZTEILE

220 – 240 V | 50 – 60 Hz | 24 V DC

Schutzklasse 1

Externe Gleichspannungsnetzteile ab Seite 240

## DC POWER SUPPLY UNITS

220 – 240 V | 50 – 60 Hz | 24 V DC

Protection class 1

External DC power supply units from page 240

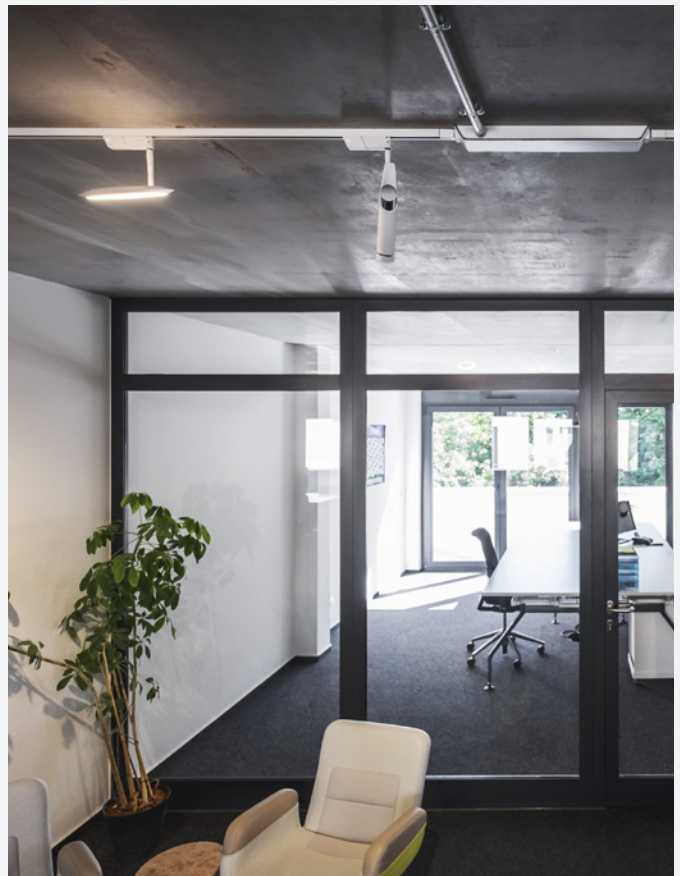

**7.1 NEWPORT 60 VA / 96 VA BÜNDIG**  
NEWPORT 60 VA / 96 VA FLUSH



422 x 48 x 32 mm

Mittel- / Endeinspeisung  
Separat bestellen: 1x / 2x Einspeisung 5.1 / 5.2  
Metall

Centre / End power supply  
Order separately: 1x / 2x power supply 5.1 / 5.2  
Metal

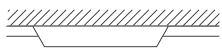

Farbe	Colour	60 VA	96 VA
Chrom matt	Matt chrome	60-142-11-06	60-142-03-06
Weiß matt	Matt white	60-142-10-21	60-142-03-21
Schwarz matt	Matt black	60-142-12-23	60-142-03-23

**7.2 NEWPORT 60 VA / 96 VA MIT TRÄGER**  
NEWPORT 60 VA / 96 VA WITH SUPPORT



422 x 48 x 32 mm

Mittel- / Endeinspeisung  
Separat bestellen: 1x / 2x Einspeisung 5.1 / 5.2  
Metall

Centre / End power supply  
Order separately: 1x / 2x power supply 5.1 / 5.2  
Metal

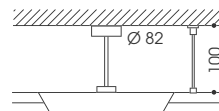

Farbe	Colour	60 VA	96 VA
Chrom matt	Matt chrome	60-142-15-06	60-142-04-06
Weiß matt	Matt white	60-142-14-21	60-142-04-21
Schwarz matt	Matt black	60-142-16-23	60-142-04-23

**7.3 NEWPORT 240 VA BÜNDIG**  
NEWPORT 240 VA FLUSH



370 x 85 x 50 mm

Mittel- / Endeinspeisung  
Separat bestellen: 1x / 2x Einspeisung 5.1 / 5.2  
Metall

Centre / End power supply  
Order separately: 1x / 2x power supply 5.1 / 5.2  
Metal



Farbe	Colour	240 VA
Chrom matt	Matt chrome	60-142-51-06
Weiß matt	Matt white	60-142-50-21
Schwarz matt	Matt black	60-142-52-23

**7.4 NEWPORT 240 VA MIT TRÄGER**  
NEWPORT 240 VA WITH SUPPORT



370 x 85 x 50 mm

Mittel- / Endeinspeisung  
Separat bestellen: 1x / 2x Einspeisung 5.1 / 5.2  
Metall

Centre / End power supply  
Order separately: 1x / 2x power supply 5.1 / 5.2  
Metal

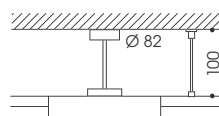

Farbe	Colour	240 VA
Chrom matt	Matt chrome	60-142-55-06
Weiß matt	Matt white	60-142-54-21
Schwarz matt	Matt black	60-142-56-23

## SMART.POINT

### STECKKONTAKTBUCHSEN

für externe Gleichspannungsnetzteile

24 V DC | max. 2 A

Schutzklasse 3

Externe Gleichspannungsnetzteile ab Seite 240

Kompatibel mit externen SMART.IQ Funkmodulen bzw. mit externem DALI-Konverter, siehe Seite 77

### PLUG-IN CONTACT SOCKETS

for external DC power supply units

24 V DC | max. 2 A

Protection class 3

External DC power supplies from page 240

Compatible with external SMART.IQ radio modules or with external DALI converter, see page 77

8.1 IN-A

Design: Ralf Keferstein



Ø 15 mm, rückseitige Verschraubung, Einbauöffnung Ø 13 mm  
Für Trockenbau mit Plattenstärken von 1 bis 10 mm  
Metall

Ø 15 mm, screw connection on the back, installation opening Ø 13 mm  
For drywall with panel thicknesses from 1 to 10 mm  
Metal

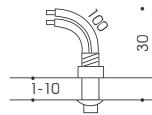

Farbe	Colour	Artikel Item
Chrom	Chrome	21-401-10-05

8.2 IN-A

Design: Ralf Keferstein



Ø 20 mm, rückseitige Verschraubung, Einbauöffnung Ø 13 mm  
Für Trockenbau mit Plattenstärken von 3 bis 25 mm  
Nicht geeignet für die Montage auf leitenden Materialien  
Metall

Ø 20 mm, screw connection at the back, installation opening Ø 13 mm  
Not suitable for mounting on conductive materials  
For drywall with panel thicknesses from 3 to 25 mm  
Metal

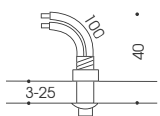

Farbe	Colour	Artikel Item
Chrom	Chrome	21-401-11-05

9.1 IN-B

Design: Ralf Keferstein



Ø 40 mm, Einbauöffnung Ø 32 mm  
Für die Montage mittels Blattfeder bei Plattenstärken von 11 – 30 mm  
Bei Montage auf Gipskartonplatten Leuchtengewicht max. 0,8 kg  
Metall

Ø 40 mm, installation opening Ø 32 mm  
For mounting by means of leaf spring for panel thicknesses of 11 - 30 mm  
For mounting on plasterboard Luminaire weight max. 0.8 kg  
Metal

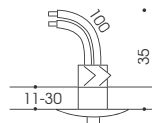

Farbe	Colour	Artikel Item
Chrom	Chrome	21-402-10-05
Chrom matt	Matt chrome	21-402-10-06
Weiß matt	Matt white	21-402-10-21

9.2 IN-B

Design: Ralf Keferstein



Ø 70 mm, Einbauöffnung Ø 58 mm  
Nur geeignet für Deckenmontage  
Geeignet zur Abdeckung einer Revisionsöffnung zum Einbau kleiner Schalt-  
netzteile  
Metall

Ø 70 mm, Installation opening Ø 58 mm  
Only suitable for ceiling mounting  
Suitable for covering an inspection opening for the installation of small  
switching power supplies  
Metal

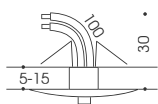

Farbe	Colour	Artikel Item
Chrom	Chrome	21-402-12-05
Chrom matt	Matt chrome	21-402-12-06
Weiß matt	Matt white	21-402-12-21

10. IN-D

Design: Ralf Keferstein



Ø 100 mm, Einbauöffnung Ø 25 - 50 mm  
Abdeckplatte für Deckenkaschierung, verdeckte Montageschrauben  
Auch für Beton-Einbaudosen  
Metall

Ø 100 mm, Installation opening Ø 25 - 50 mm  
Cover plate for ceiling lamination, concealed mounting screws  
Also for concrete recessed boxes  
Metal

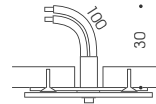

Farbe	Colour	Artikel Item
Chrom	Chrome	21-404-10-05
Chrom matt	Matt chrome	21-404-10-06
Weiß matt	Matt white	21-404-10-21

## BALDACHIN

inklusive Schaltnetzteil und Steckkontaktbuchse

230 V | 50 – 60 Hz | 24 V DC

Schutzklasse 1

Das Gehäuse ist für den Einbau eines DALI-Konverter geeignet,  
siehe Seite 77

## CANOPY

including DC power supply unit and plug-in contact  
socket

230 V | 50 – 60 Hz | 24 V DC

Protection class 1

The housing is suitable for the installation of a DALI converter,  
see page 77

11. LOCAL-A

Design: Ralf Keferstein



1x 18 VA

Ø 87 x H 45 mm

Metall  
Metal

Farbe	Colour	Artikel Item
Chrom	Chrome	21-453-10-05
Chrom matt	Matt chrome	21-453-10-06
Weiß matt	Matt white	21-453-10-21

## SMART.TRACK

### SMART.IQ

Adapter für die digitale Lichtsteuerung

Zur funkbasierten Steuerung über Casambi oder HomeMatic Kompatible Taster und Fernbedienungen ab Seite 238

Mehr zu Casambi und HomeMatic auf Seite 19

### SMART.IQ

Adapter for digital lighting control

For radio-based control via Casambi or HomeMatic Compatible push-buttons and remote controls from page 238

More about Casambi and HomeMatic on page 19



#### 12. CASAMBI



24 V DC | 2,4 GHz Bluetooth 4.0 LE

Erweiterung für Leuchten mit SMART.TRACK Adapter mit Buchse oder für SMART.TRACK Leuchten mit integriertem Adapter (HUBBLE, BALINO, RIO) Ermöglicht die Steuerung kompatibler Leuchten über Casambi

Extension for luminaires with SMART.TRACK adapter with plug or for SMART.TRACK luminaires with integrated adapter (HUBBLE, BALINO, RIO) Enables control of compatible luminaires via Casambi

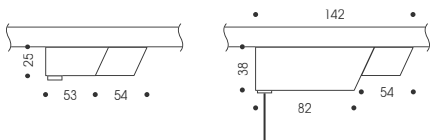

#### 13. HOME MATIC



24 V DC | 868,3 MHz HomeMatic BidCoS

Erweiterung für Leuchten mit SMART.TRACK Adapter mit Buchse oder für SMART.TRACK Leuchten mit integriertem Adapter (HUBBLE, BALINO, RIO) Ermöglicht die Steuerung kompatibler Leuchten über HomeMatic

Extension for luminaires with SMART.TRACK adapter with plug or for SMART.TRACK luminaires with integrated adapter (HUBBLE, BALINO, RIO) Enables control of compatible luminaires via HomeMatic

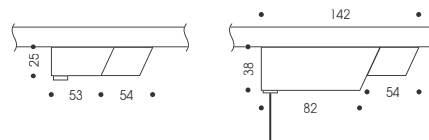

Farbe	Colour	Artikel Item
Chrom matt	Matt chrome	23-625-10-06
Weiß matt	Matt white	23-625-10-21
Schwarz matt	Matt black	23-625-10-23

Farbe	Colour	Artikel Item
Chrom matt	Matt chrome	23-625-11-06
Weiß matt	Matt white	23-625-11-21
Schwarz matt	Matt black	23-625-11-23

## SMART.POINT

### SMART.IQ

#### Einbaumodule für die digitale Lichtsteuerung

Zur funkbasierten Steuerung über Casambi oder HomeMatic Kompatible Taster und Fernbedienungen ab Seite 238

Mehr zu Casambi und HomeMatic auf Seite 19

Zur leitungsgebundenen Steuerung über DALI

Mehr zu DALI auf Seite 19 und 138

### SMART.IQ

#### Built-in modules for digital lighting control

For radio-based control via Casambi or HomeMatic Compatible push-buttons and remote controls from page 238

More about Casambi and HomeMatic on page 19

For cable-based control via DALI

More about DALI on page 19 and 138

#### 14. CASAMBI



82 x 40 x 23 mm  
24 V DC | 2,4 GHz Bluetooth 4.0 LE

Geeignet für abgehängte, funkdurchlässige Decken  
Ermöglicht die Steuerung kompatibler Leuchten über Casambi

Suitable for suspended, radio-permeable ceilings  
Enables control of compatible luminaires via Casambi

Typ	Type	Artikel Item
Funkmodul	Radio module	60-312-10-00

#### 15. HOME MATIC



82 x 40 x 23 mm  
24 V DC | 868,3 MHz HomeMatic BidCoS

Geeignet für abgehängte, funkdurchlässige Decken  
Ermöglicht die Steuerung kompatibler Leuchten über HomeMatic

Suitable for suspended, radio-permeable ceilings  
Enables control of compatible luminaires via HomeMatic

Typ	Type	Artikel Item
Funkmodul	Radio module	60-312-11-00

#### 16. DALI



41 x 28 x 14 mm

Geeignet für abgehängte Decken und Einbaudosen sowie LOCAL-A  
Ermöglicht als Aktor die Steuerung einer oder mehrerer DALI-kompatibler SMART.POINT Leuchten

Suitable for suspended ceilings and recessed boxes and LOCAL-A  
As an actuator, enables control of one or more DALI-compatible SMART.POINT luminaires

Typ	Type	Artikel Item
DALI Konverter	DALI converter	60-311-10-00







# CHECK-IN

## 230 V SYSTEM

Design: Ralf Keferstein

### 230 V IM KLEINEN FORMAT

CHECK-IN ist ein schlankes, einphasiges 230 Volt Schienensystem, mit dem sich Beleuchtungskonzepte in geraden Linien, eleganten Schwüngen oder Kreisen verwirklichen lassen.

Das patentierte und prämierte System besteht aus einem hochfesten Aluminiumprofil und einem umfangreichen Leuchtenprogramm. Es gehört mit den Maßen von 22 x 8 Millimetern weltweit zu den kleinsten seiner Art und besticht durch eine klare, reduzierte Formensprache.

Unterschiedliche Lichttechniken ermöglichen es, CHECK-IN gleichermaßen im privaten Wohnraum wie auch im Einzelhandel und Objektbereich einzusetzen.

Für individuell geschwungene Schienenverläufe und Kreise werden die Schienen werkseitig nach Kundenwunsch gebogen.

### 230 VOLTS IN A COMPACT DESIGN

CHECK-IN is a slim, single-phase 230 volt track system with which lighting concepts in straight lines, elegant curves or circles can be realised.

The patented and award-winning system consists of a highstrength aluminium profile and an extensive range of luminaires. With dimensions of 22 x 8 millimetres, it is among the smallest of its type in the world and stands out with clear, minimalist design language.

A variety of lighting technologies make CHECK-IN as usable in private living space as it is in the retail sector and property.

For individual curved track configurations and circles, the tracks are curved in the factory upon request by the customer.



# ÜBERSICHT OVERVIEW

## LED

Strahler und  
Raumlichter  
Spots and  
ambient lights



ROCKET  
84

SPHERE  
85

KELVEEN  
86

WALLEY  
87

Pendelleuchten  
Pendant  
luminaires



ROCKET  
106

GRACE  
108

## Halogen | Retrofit

Strahler und  
Raumlichter  
Spots and  
ambient lights



TWIN LANE  
89

LEVEL  
89

ICE  
90

GATE B SEVEN  
92



GATE B SEVEN GALERIE  
93

MATCH  
95

HIGH STREAM 16  
95

MX-HIGH  
96

GATE B FOUR  
97

## Halogen | Retrofit

Strahler und  
RaumlichterSpots and  
ambient lightsGATE B EIGHT  
98BTUBE  
99HIGH FLIGHT  
100JUST KIDDING  
101BALIBU  
102MAGIC  
105MADEMOISELLE FILOU  
105

## Pendelleuchten

Pendant  
luminairesGRACE  
109PULL-IT 3  
110PULL-IT  
111BALIBU BEACH  
113BENE  
113PLUG-IN  
Leuchten  
(über Adapter)PLUG-IN  
luminaires  
(via adapter)CONTACT TUBE  
Adapter Adapter 115  
Leuchten Luminaires 209

# CHECK-IN INSTALLATION



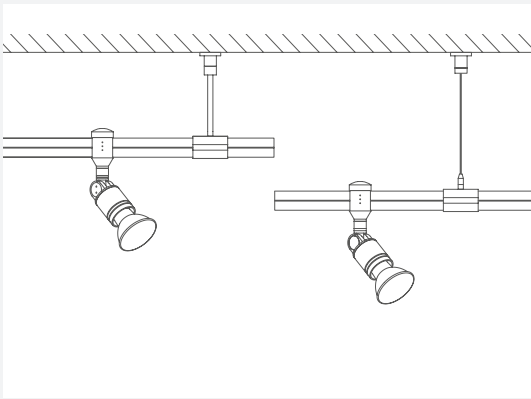

#### FLEXIBLE INSTALLATIONSMÖGLICHKEITEN

CHECK-IN Schienen lassen sich mühelos kürzen und nahezu werkzeuglos montieren. Dank zahlreicher Distanzträger und Seilabhängungen ist eine flexible Deckenmontage möglich. Ebenso lassen sich durch Wandträger und dazugehörige Galeriestrahler kreative Lösungen realisieren.

#### FLEXIBLE INSTALLATION OPTIONS

CHECK-IN tracks can easily be shortened and mounted almost without tools. An extensive range of distance supports and cable suspensions allows for different forms of ceiling installation. Creative solutions can also be realised with wall support and associated gallery spotlights.

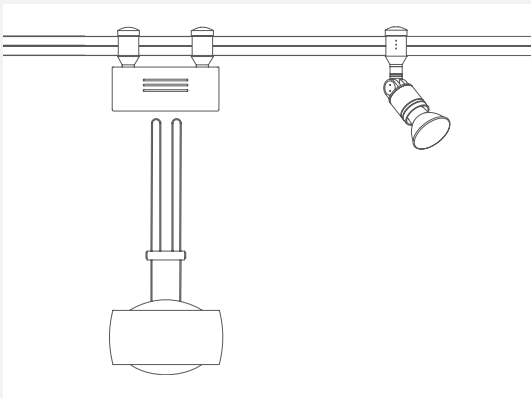

#### EINFACH UND SICHER MONTIEREN

CHECK-IN Systemleuchten sind ab Werk mit einem Adapter ausgestattet. Die Leuchtenauswahl ist nicht auf das CHECK-IN Systemprogramm beschränkt. Höhenverstellbare 12 V Pendelleuchten können mittels des Adapters KEEP ON ROLLING problemlos in das System eingefügt werden.

#### INSTALL EASILY AND SAFELY

CHECK-IN system luminaires are equipped with an adapter in the factory. The choice of luminaires is not limited to the CHECK-IN system range. Height adjustable 12 volt pendant luminaires can be easily integrated into the system using the KEEP ON ROLLING adapter.

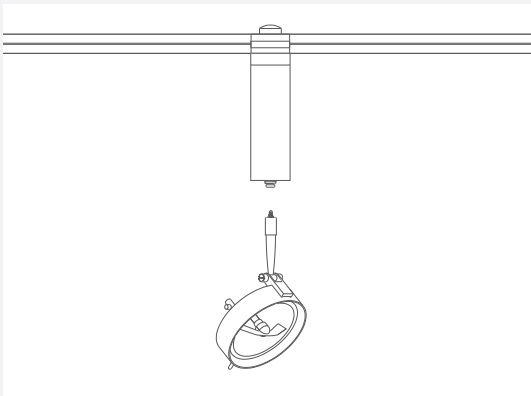

#### JEDERZEIT ERWEITERBAR

Mit dem Adapter CONTACT TUBE können sämtliche 12 V PLUG-IN Leuchten in das Schienensystem CHECK-IN integriert werden. Hierdurch eröffnet sich eine zusätzliche gestalterische Vielfalt.

#### EXPANDABLE AT ANY TIME

With the CONTACT TUBE adapter, all 12 volt PLUG-IN luminaires can be integrated into the CHECK-IN track system. This opens up additional design versatility.

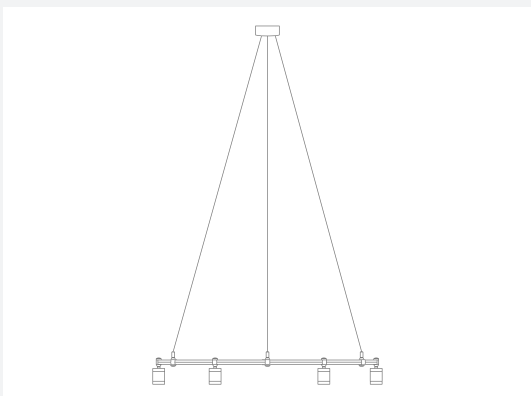

#### DAS HIGHLIGHT IM RAUM

Aufgrund der filigranen Abmessungen können CHECK-IN Schienen in individuellen Schwüngen oder Kreisen gebogen werden. BEAUTY FREE Schienenkreise mit unterschiedlichem Durchmesser können in Einzel- oder Mehrfachhängung konfektioniert werden und stellen eine ebenso dezente wie festliche Beleuchtungslösung dar.

#### THE HIGHLIGHT IN THE ROOM

Owing to their delicate dimensions, CHECK-IN tracks can be bent into individual curves or circles. BEAUTY FREE track circles with various diameters can be fabricated in single or multiple suspension and represent a lighting solution which is as subtle as it is solemn.



## ROCKET



## Strahler

Drehbar, schwenkbar

Aluminium, Glaslinse

## Spotlight

Rotatable, swiveling

Aluminium, glass lens

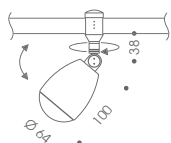

230 V | 50-60 Hz 0,5 kg

LED | 2700 K | 450 lm | 8 W | 90° | CRI &gt;90

Leuchte Luminaire

Artikel Item

Chrom  
Chrome

30-853-10-05

Chrom matt  
Matt chrome

30-853-10-06



EXTERN  
DIMMBAR

CHECK-IN

# SPHERE



Strahler

Metall, Glaslinse

Spotlight

Metal, glass lens

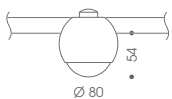

230 V | 50-60 Hz 0,6 kg

LED | 2700 K | 700 lm | 8,8 W | 90° | CRI >90

Leuchte Luminaire

Artikel Item

Chrom  
Chrome

30-852-10-05

Chrom matt  
Matt chrome

30-852-10-06



# KELVEEN



Chrom matt  
Matt chrome

## Strahler

Drehbar, schwenkbar

Metall, Glaslinse

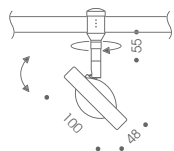

230 V | 50-60 Hz | 0,7 kg

## Spotlight

Rotatable, swiveling

Metal, glass lens

LED | 2700 K | 450 lm | 8 W | 90° | CRI >90

Leuchte Luminaire

Artikel Item

Chrom matt  
Matt chrome

30-869-10-06





EXTERN  
DIMMBAR

CHECK-IN

# WALLEY

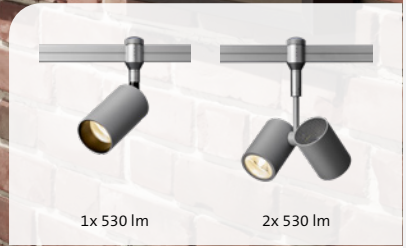

### Strahler

Drehbar, Köpfe einzeln schwenkbar

Metall

### Spotlight

Rotatable, heads individually swiveling

Metal

1x 530 lm

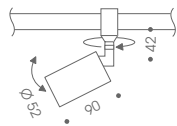

230 V | 50-60 Hz 0,3 kg

2x 530 lm

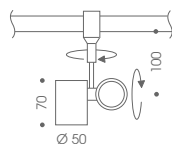

230 V | 50-60 Hz 0,5 kg

LED | 2700 K | 1x 530 lm | 8 W | 30° | CRI >90

LED | 2700 K | 2x 530 lm | 16 W | 30° | CRI >90

Leuchte Luminaire	Typ Type	Artikel Item
Chrom matt Matt chrome	1x 530 lm	30-858-10-06
Chrom matt Matt chrome	2x 530 lm	30-858-20-06



LEVEL



EXTERN  
DIMMBAR



FÜR RETROFIT  
GEEIGNET

CHECK-IN

## TWIN LANE



Chrom  
Chrome



Chrom matt  
Matt chrome

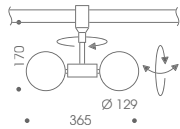

230 V 0,8 kg

Strahler

Drehbar, Leuchtenköpfe kardanisch

Aluminium

Spotlight

Rotatable, gimbal-mounted luminaire heads

Aluminium

GZ 10 | QPAR 111 Halogen max. 2x 75 W | Retrofit

Leuchte Luminaire	Artikel Item
Chrom Chrome	30-866-10-05
Chrom matt Matt chrome	30-866-10-06

## LEVEL

Design: Ralf Keferstein



Chrom  
Chrome



Chrom matt  
Matt chrome

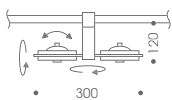

230 V 0,5 kg

Strahler

Drehbar, Leuchtenköpfe kardanisch

Aluminium

Spotlight

Rotatable, gimbal-mounted luminaire heads

Aluminium

GZ 10 | QPAR 111 Halogen max. 2x 75 W | Retrofit

Leuchte Luminaire	Artikel Item
Chrom Chrome	30-905-21-05
Chrom matt Matt chrome	30-905-21-06

# ICE

Design: Ralf Keferstein





EXTERN  
DIMMBAR



FÜR RETROFIT  
GEEIGNET

CHECK-IN

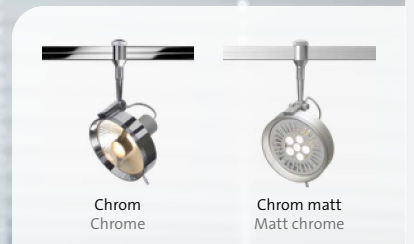

Strahler

Drehbar, schwenkbar

Aluminium

Spotlight

Rotatable, swiveling

Aluminium

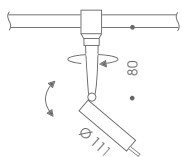

230 V 0,4 kg

GZ 10 | QPAR 111 Halogen max. 75 W | Retrofit

Leuchte Luminaire	Artikel Item
Chrom Chrome	30-916-10-05
Chrom matt Matt chrome	30-916-10-06



EXTERN  
DIMMBAR



FÜR RETROFIT  
GEEIGNET

# GATE B SEVEN

Design: Ralf Keferstein

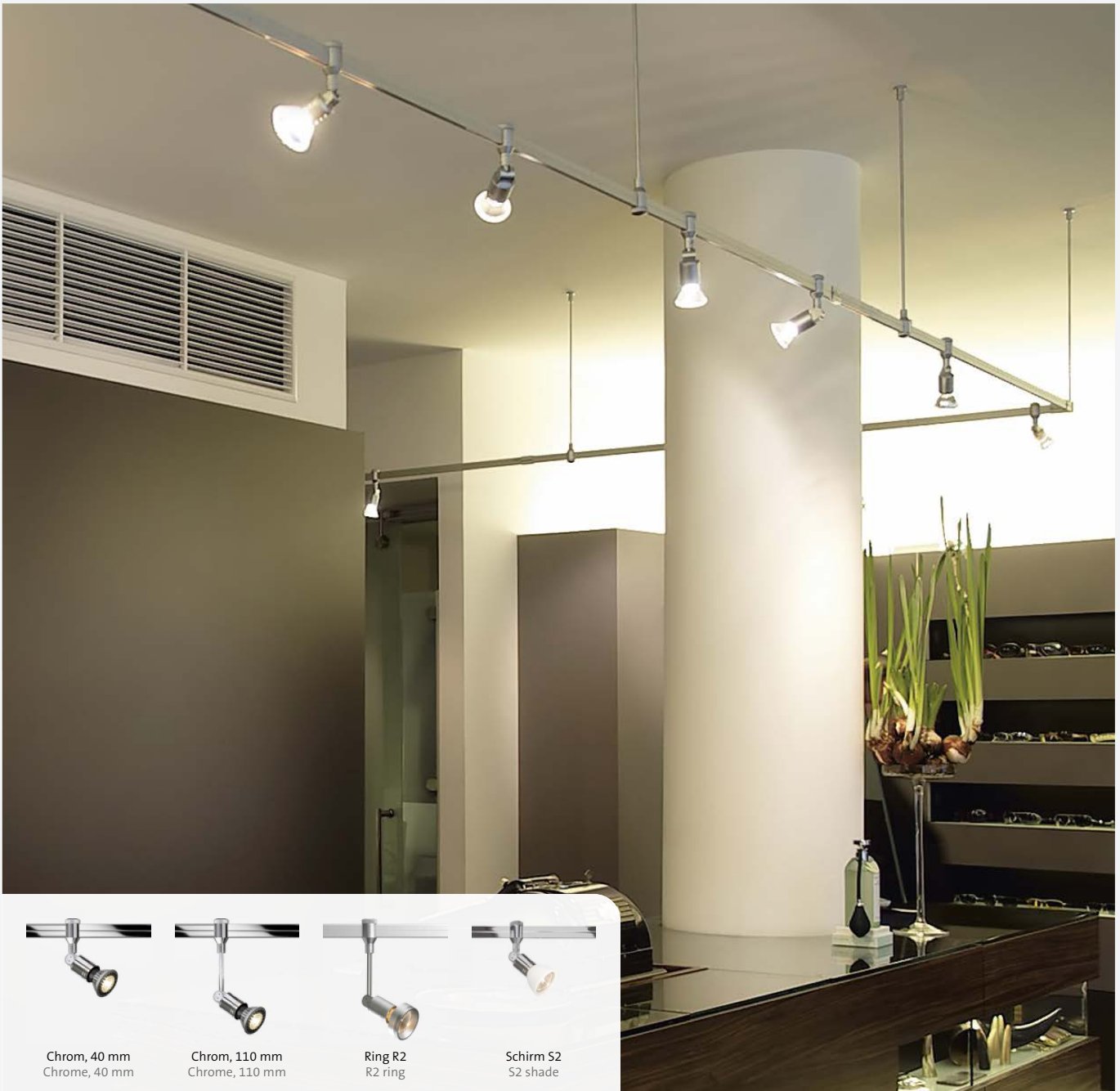

Chrom, 40 mm  
Chrome, 40 mm



Chrom, 110 mm  
Chrome, 110 mm



Ring R2  
R2 ring



Schirm S2  
S2 shade

Strahler

Drehbar, schwenkbar

Aluminium

Spotlight

Rotatable, swiveling

Aluminium

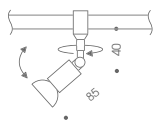

230 V 0,2 kg

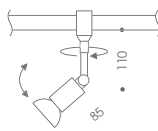

230 V 0,2 kg

GZ 10 | QPAR 51/64 Halogen max. 50/75 W | Retrofit

Leuchte Luminaire	Stange 40 mm Rod	Stange 110 mm Rod
Chrom Chrome	30-973-10-05	30-973-11-05
Chrom matt Matt chrome	30-973-10-06	30-973-11-06

Leuchtmittelzubehör ab Seite 244  
Lamp accessories from page 244



EXTERN  
DIMMBAR



FÜR RETROFIT  
GEEIGNET

CHECK-IN

# GATE B SEVEN GALERIE

Design: Ralf Keferstein

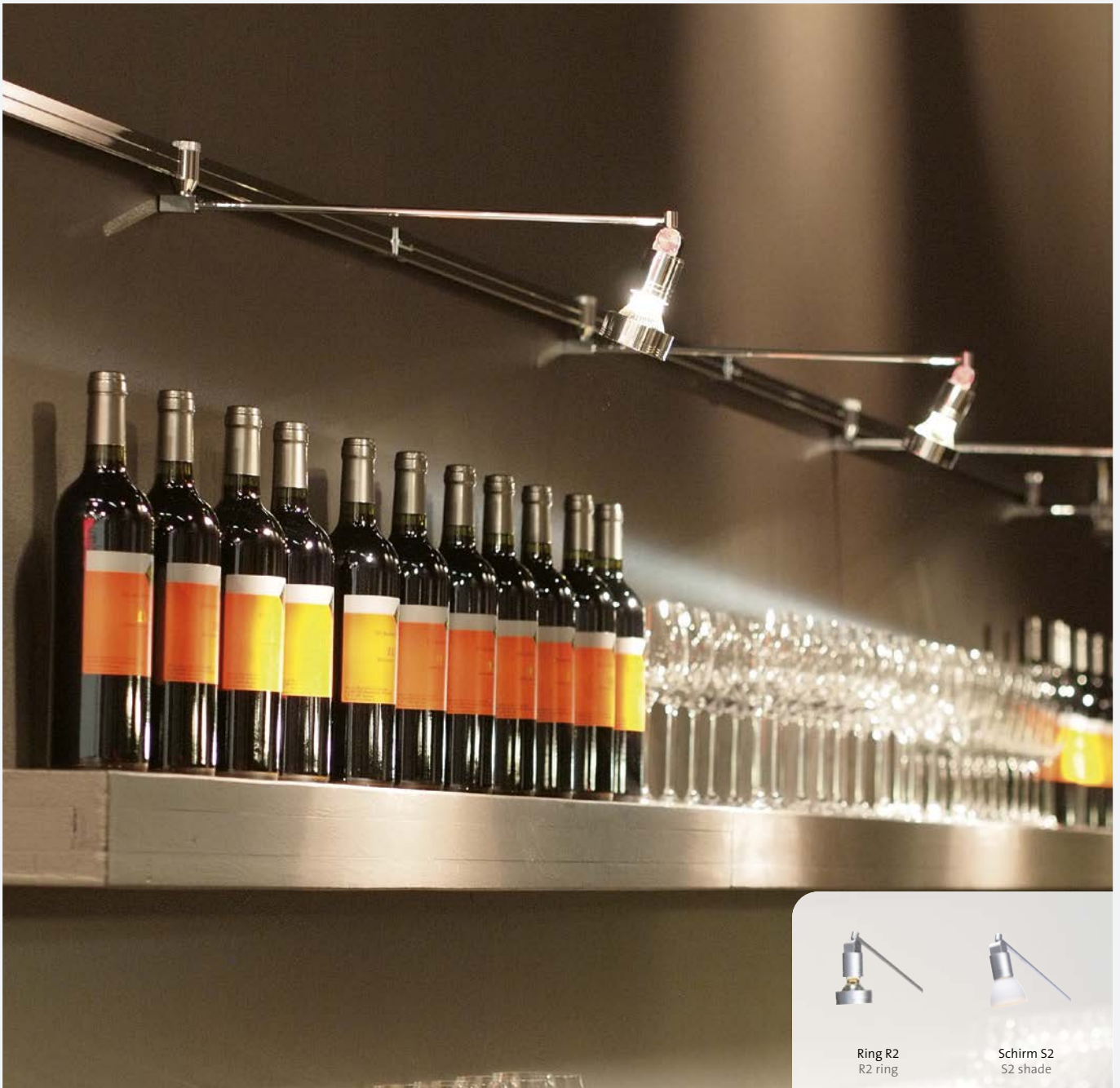

Ring R2  
R2 ring



Schirm S2  
S2 shade

Galeriestrahler

Kopf schwenkbar

Aluminium

Gallery light

Head swiveling

Aluminium

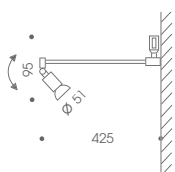

230 V 0,2 kg

GZ 10 | QPAR 51/64 Halogen max. 50/75 W | Retrofit

Leuchte Luminaire

Artikel Item

Chrom  
Chrome

30-973-20-05

Chrom matt  
Matt chrome

30-973-20-06

Leuchtmittelzubehör ab Seite 244  
Lamp accessories from page 244



MATCH





EXTERN  
DIMMBAR



FÜR RETROFIT  
GEEIGNET

CHECK-IN

# MATCH

Design: Ralf Keferstein



Chrom, Ring R2  
Chrome, R2 ring

Chrom matt  
Matt chrome

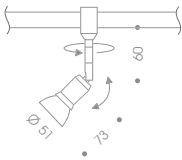

230 V 0,3 kg

Strahler  
Drehbar, schwenkbar  
Aluminium

Spotlight  
Rotatable, swiveling  
Aluminium

GZ 10 | QPAR 51 Halogen max. 50 W | Retrofit

Leuchte Luminaire	Artikel Item
Chrom Chrome	30-892-10-05
Chrom matt Matt chrome	30-892-10-06

Leuchtmittelzubehör ab Seite 244  
Lamp accessories from page 244

# HIGH STREAM 16

Design: Ralf Keferstein



Chrom  
Chrome

Chrom matt  
Matt chrome

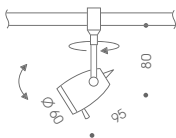

230 V 0,3 kg

Strahler  
Drehbar, schwenkbar  
Halogen: "Cool beam" Leuchtmittel nicht zulässig  
Retrofit: Gesamtlänge ≤52 mm empfohlen

Metall  
Spotlight  
Rotatable, swiveling  
Halogen: "Cool beam" lamp not permitted  
Retrofit: total length ≤52 mm recommended

Metal

GZ 10 | QPAR 51 Halogen max. 50 W | Retrofit

Leuchte Luminaire	Artikel Item
Chrom Chrome	30-968-10-05
Chrom matt Matt chrome	30-968-11-06



EXTERN  
DIMMBAR



FÜR RETROFIT  
GEEIGNET

# MX-HIGH

Design: Ralf Keferstein



## Strahler

Drehbar, schwenkbar

Metall

## Spotlight

Rotatable, swiveling

Metal

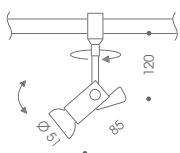

230 V 0,4 kg

GZ 10 | QPAR 51 Halogen max. 50 W | Retrofit

Leuchte Luminaire	Artikel Item
Chrom matt Matt chrome	30-958-10-06

Leuchtmittelzubehör Schirm Ø 100 siehe unten, weiteres Zubehör ab Seite 244  
Shade Ø 100 accessory see below, further accessories from page 244

Zubehör Accessory				
Typ Type	Material Material	Farbe Colour	Artikel Item	
Schirm Ø 100 mm Shade Ø 100 mm	Metall Metal	Chrom matt Matt chrome	62-214-10-06	
	Glas Glass	Weiß matt Matt white	62-214-10-21	



EXTERN  
DIMMBAR



FÜR RETROFIT  
GEEIGNET

CHECK-IN

# GATE B FOUR

Design: Ralf Keferstein



Raumlicht (G 9) oder Strahler (GZ10)

Drehbar, schwenkbar  
Version GZ 10 optional ohne Schirm nutzbar

Aluminium, Glas mundgeblasen

Ambient light (G 9) or spotlight (GZ10)

Rotatable, swiveling  
Version GZ 10 optionally usable without shade

Aluminium, hand-blown glass

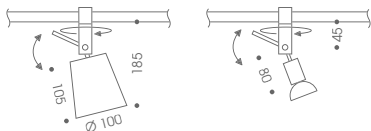

230 V 0,7 kg

230 V 0,2 kg

G 9 | QT-14 Halogen max. 75 W | Retrofit  
GZ 10 | QPAR 51/64 Halogen max. 50/75 W | Retrofit

Leuchte Luminaire	G 9	GZ 10
Chrom Chrome	30-904-20-05	30-904-10-05
Chrom matt Matt chrome	30-904-20-06	30-904-10-06

Schirm separat bestellen  
Order shade separately

G 9 Schirm G 9 shade

Farbe Colour	Artikel Item
Weiß matt Matt white	94-904-10-21
Champagner Champagne	94-904-10-42

GZ 10 Schirm GZ 10 shade

Farbe Colour	Artikel Item
Transparent Transparent	94-904-10-01

230 V SYSTEM



EXTERN  
DIMMBAR



FÜR RETROFIT  
GEEIGNET

# GATE B EIGHT

Design: Ralf Keferstein

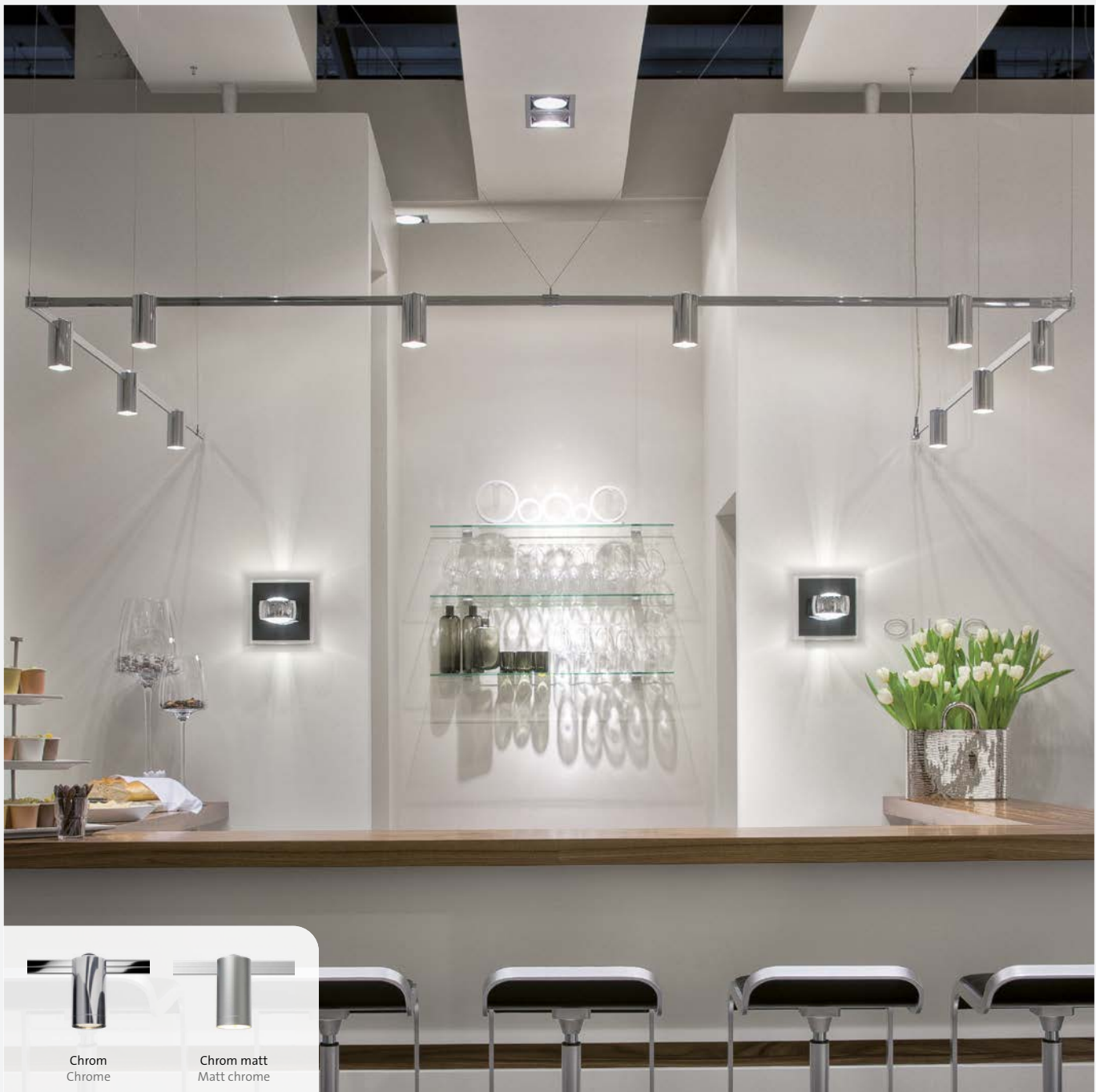

Chrom  
Chrome

Chrom matt  
Matt chrome

Strahler  
Aluminium

Spotlight  
Aluminium

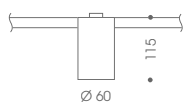

230 V 0,3 kg

GZ 10 | QPAR 51 Halogen max. 50 W | Retrofit

Leuchte Luminaire	Artikel Item
Chrom Chrome	30-902-10-05
Chrom matt Matt chrome	30-902-10-06



EXTERN  
DIMMBAR



FÜR RETROFIT  
GEEIGNET

CHECK-IN

# B TUBE

Design: Ralf Keferstein



## Strahler

Aluminium, Borosilikatglas

## Spotlight

Aluminium, borosilicate glass

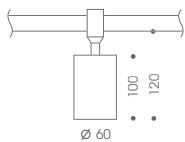

230 V 0,3 kg

GZ 10 | QPAR 51 Halogen max. 50 W | Retrofit

Leuchte Luminaire	Schirm Shade	Artikel Item
Chrom Chrome	Teilsatiniert Partial satin finished	30-993-10-05
Chrom matt Matt chrome	Teilsatiniert Partial satin finished	30-993-10-06



EXTERN  
DIMMBAR



FÜR RETROFIT  
GEEIGNET

# HIGH FLIGHT

Design: Ralf Keferstein



Raumlicht

Drehbar, schwenkbar  
Stange 40 bzw. 140 mm

Aluminium, temperaturbeständige Folie

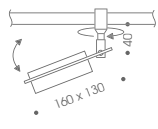

230 V 0,3 kg

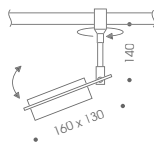

230 V 0,3 kg

Ambient light

Rotatable, swiveling  
Rod 40 or 140 mm

Aluminium, temperature-resistant foil

G 9 | QT 14 Halogen max. 75 W | Retrofit

Adapter	Adapter	Korpus Body	Stange 40 mm Rod	Stange 140 mm Rod
Chrom Chrome	Chrom matt Chrome		30-969-10-06	30-969-20-06
Chrom matt Matt chrome	Chrom matt Matt chrome		30-969-11-06	30-969-21-06



EXTERN  
DIMMBAR



FÜR RETROFIT  
GEEIGNET

CHECK-IN

# JUST KIDDING

Design: Ralf Keferstein



Chrom matt  
Matt chrome

JUST KIDDING, LEVEL

Raumlicht

Drehbar

Retrofit: Ø max. 20 mm, Länge max. 43 mm

Metall, Glas

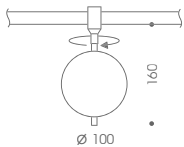

230 V 0,4 kg

Ambient light

Rotatable

Retrofit: Ø max. 20 mm, length max. 43 mm

Metal, glass

G 9 | QT 14 Halogen max. 40 W | Retrofit

Leuchte Luminaire	Schirm Shade	Artikel Item
Chrom matt Matt chrome	Satiniert Satin finished	30-964-10-06/21

# BALIBU



Weiß matt  
Matt white

Ananas  
Pineapple

Melon  
Melon

Teilsatiniert  
Partly satinised





EXTERN  
DIMMBAR



FÜR RETROFIT  
GEEIGNET

CHECK-IN

Design: Ralf Keferstein



BALIBU, GATE B SEVEN

**Raumlicht**

Leuchte muss nach unten ausgerichtet montiert werden

Aluminium, Glas mundgeblasen

Ambient light

Luminaire must be installed pointing downwards

Aluminium, hand-blown glass

**G 9 | QT 14 Halogen max. 40 W | Retrofit**

Adapter Adapter	Schirm Shade	Artikel Item
Chrom Chrome	Weiß matt Matt white	30-991-10-05/21
Chrom matt Matt chrome	Weiß matt Matt white	30-991-10-06/21
Chrom matt Matt chrome	Ananas Pineapple	30-991-10-06/32
Chrom matt Matt chrome	Melon Melon	30-991-10-06/28

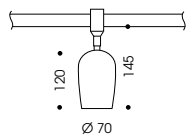

230 V 0,4 kg

**GU 10 | QPAR 51 Halogen max. 50 W | Retrofit**

Adapter Adapter	Schirm Shade	Artikel Item
Chrom Chrome	Teilsatiniert Partial satin finished	30-991-11-05/02
Chrom matt Matt chrome	Teilsatiniert Partial satin finished	30-991-11-06/02



Foto: Fingerhaus Musterhaus



EXTERN  
DIMMBAR

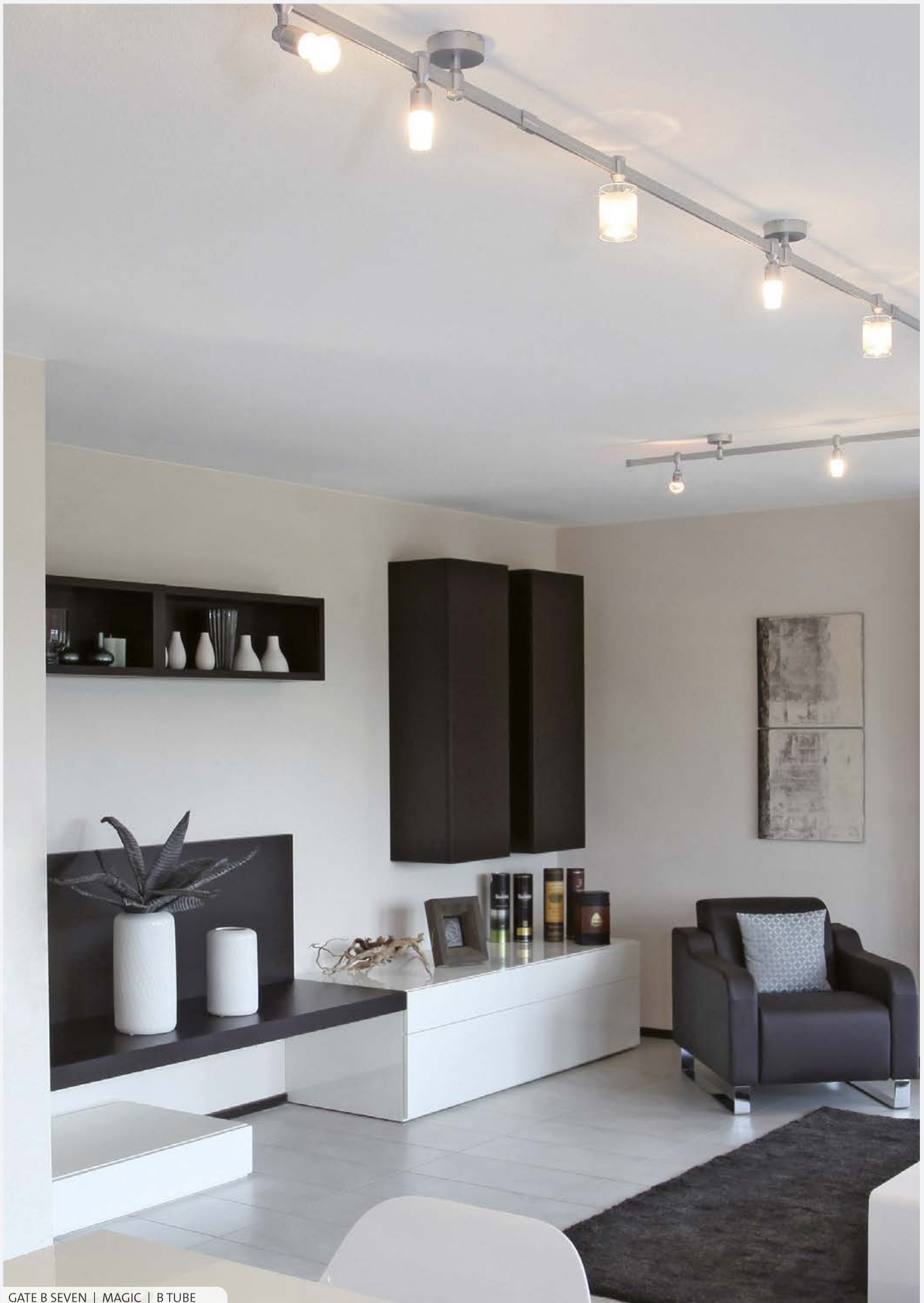

FÜR RETROFIT  
GEEIGNET

CHECK-IN

# MAGIC

Design: Ralf Keferstein



Raumlicht

Metall, Borosilikatglas

Ambient light

Metal, borosilicate glass

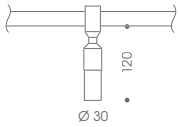

230 V 0,2 kg

G 9 | QT 14 Halogen max. 40 W | Retrofit

Leuchte Luminaire	Schirm Shade	Artikel Item
Chrom matt Matt chrome	Satiniert Satin finished	30-961-10-06/21

# MADEMOISELLE FILOU

Design: Sigi Bussinger



Raumlicht

Flexarm  
Flügel und Rüssel schwenkbar

Metall, Kunststoff, temperaturbeständiges Strukturgewebe

Ambient light

Flexible arm  
Swivelling wings and trunk

Metal, plastic, temperature-resistant structural fabric

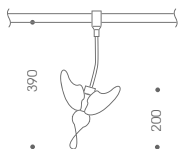

230 V 0,3 kg

E 14 | D 45-CS Konventionell max. 25 W | Retrofit

Adapter Adapter	Korpus Body	Artikel Item
Chrom matt Matt chrome	Schwarz matt Matt black	30-980-10-23

# ROCKET





EXTERN  
DIMMBAR

CHECK-IN



Chrom  
Chrome



Chrom matt  
Matt chrome

Pendelleuchte

Kürzbar  
Abhängung auf Anfrage bis 5 m Länge

Metall, Glas

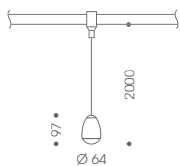

230 V | 50-60 Hz 0,6 kg

Pendant luminaire

Can be shortened  
Suspension up to 5 m length on request

Metal, glass

LED | 2700 K | 450 lm | 8 W | 90° | CRI >90

Leuchte Luminaire

Artikel Item

Chrom  
Chrome

30-853-20-05

Chrom matt  
Matt chrome

30-853-20-06

# GRACE

Design: Ralf Keferstein



## Pendelleuchte

Kürzbar  
Abhängung auf Anfrage bis 5 m Länge

Metall, Glas

### Pendant luminaire

Can be shortened  
Suspension up to 5 m length on request

Metal, glass

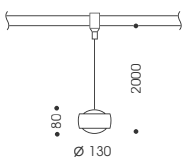

230 V | 50-60 Hz | 1,1 kg

LED | 2700 K | 1400 lm | 20 W | CRI >90

Leuchte Luminaire	Adapter:	Chrom Chrome	Chrom matt Matt chrome
Chrom Chrome		30-931-40-05	
Aluminium gebürstet Brushed aluminium			30-931-40-12
Weiß glänzend Bright white		30-931-40-20	30-931-41-20
Satin copper Satin copper		30-931-40-15	30-931-41-15
Brazilian brown Brazilian brown		30-931-40-41	30-931-41-41
Espresso Espresso		30-931-40-48	30-931-41-48
Purple grey Purple grey		30-931-40-49	30-931-41-49



EXTERN  
DIMMBAR

CHECK-IN

# GRACE

Design: Ralf Keferstein



Chrom  
Chrome



Aluminium gebürstet  
Brushed aluminium

## Pendelleuchte

Höhenverstellbar, kürzbar  
Abhängung auf Anfrage bis 5 m erhältlich

Metall, Glas

## Pendant luminaire

Height adjustable, can be shortened  
Suspension available up to 5 m on request

Metal, glass

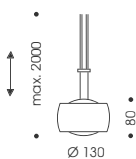

12 V 0,7 kg

GY 6,35 | QT-LP 12 Halogen max. 50 W | Retrofit

Leuchte Luminaire

Artikel Item

Chrom  
Chrome

10-931-10-05

Aluminium gebürstet  
Brushed aluminium

10-931-10-12

Adapter KEEP ON ROLLING separat bestellen auf Seite 115  
Order KEEP IN ROLLING adapter separately on page 115

230 V SYSTEM



EXTERN  
DIMMBAR



FÜR RETROFIT  
GEEIGNET

# PULL-IT 3

Design: Ralf Keferstein



Transparent  
Transparent

Weiß matt  
Matt white

## Pendelleuchte

Kürzbar  
Abhängung auf Anfrage bis 5 m erhältlich

Aluminium, Glas

## Pendant luminaire

Can be shortened  
Suspension available up to 5 m on request

Aluminium, glass

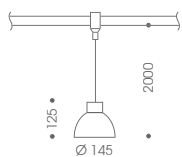

230 V 0,8 kg

G 9 | QT 14 Halogen max. 60 W | Retrofit

Adapter	Adapter	Leuchte Luminaire	Artikel Item
Chrom matt Matt chrome	Transparent Transparent	30-952-10-06/01	
Chrom matt Matt chrome	Weiß matt Matt white	30-952-10-06/21	





EXTERN  
DIMMBAR

CHECK-IN

# PULL-IT

Design: Ralf Keferstein



red dot

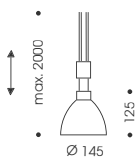

12 V 1,4 kg

### Pendelleuchte

Höhenverstellbar, kürzbar  
Abhängung auf Anfrage bis 5 m  
erhältlich

Metall, Glas mundgeblasen

### Pendant luminaire

Height adjustable, can be shortened  
Suspension available up to 5 m on  
request

Metal, hand-blown glass

GY 6,35 | QT-LP 12 Halogen max. 50 W | Retrofit

Leuchte Luminaire	Artikel Item
Transparent Transparent	10-952-10-06/01
Weiß matt Matt white	10-952-10-06/21

Adapter KEEP ON ROLLING separat bestellen auf Seite 115  
Order KEEP IN ROLLING adapter separately on page 115



BENE



EXTERN  
DIMMBAR



FÜR RETROFIT  
GEEIGNET

CHECK-IN

# BALIBU BEACH

Design: Ralf Keferstein



Pendelleuchte

Kürzbar  
Abhängung auf Anfrage bis 5 m erhältlich

Aluminium, mundgeblasenes Glas

Pendant luminaire

Can be shortened  
Suspension available up to 5 m on request

Aluminium, hand-blown glass

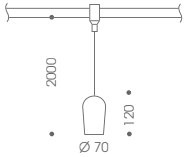

230 V 0,4 kg

G 9 | QT 14 Halogen max. 40 W | Retrofit

Leuchte Luminaire	Schirm Shade	Artikel Item
Chrom matt Matt chrome	Weiß matt Matt white	30-991-20-06/21

# BENE

Design: Ralf Keferstein



Pendelleuchte

Kürzbar  
Abhängung auf Anfrage bis 5 m erhältlich

Aluminium, mundgeblasenes Glas

Pendant luminaire

Can be shortened  
Suspension available up to 5 m on request

Aluminium, hand-blown glass

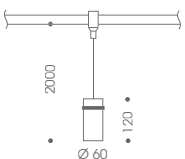

230 V 0,4 kg

G 9 | QT 14 Halogen max. 60 W | Retrofit

Leuchte Luminaire	Schirm Shade	Artikel Item
Chrom matt Matt chrome	Weiß matt Matt white	30-935-10-06/21



KEEP ON ROLLING | GRACE

## KEEP ON ROLLING

Design: Ralf Keferstein

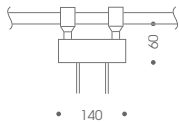

Kompatibel mit Compatible with

GRACE  
109PULL-IT  
111

230 V | 50-60 Hz | 12 V 0,6 kg



Systemadapter für 12 V Pendelleuchten mit Höhenverstellung

Sekundärseitig zulässige Leitungslänge <2m  
Elektronischer Transformator, kompatibel mit Dimmer "Typ C" oder elektronischer Transformator mit Berührungsdimmer, nicht extern dimmbar

Metall

System adapter for 12 V pendant luminaires with height adjustment

Permissible cable length on secondary side <2m  
Electronic transformer, compatible with "Type C" dimmer or electronic transformer with touch dimmer, not externally dimmable

Metal

20-60 VA

Typ Type	Farbe Colour	Artikel Item
Elektronischer Transf. Electronic transformer	Chrom matt Matt chrome	31-641-10-06
Berührungsdimmer Touch dimmer	Chrom matt Matt chrome	T31-641-10-06

Leuchten separat bestellen  
Order luminaires separately

## CONTACT TUBE

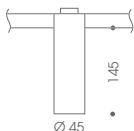

Kompatibel mit (Beispiele) Compatible with (Examples)

CHARLES  
221DONATA  
228COCO  
229

230 V | 50-60 Hz | 12 V 0,4 kg

Systemadapter für 12 V Steckkontaktleuchten

Sekundärseitig zulässige Leitungslänge <2m  
Elektronischer Transformator, kompatibel mit Dimmer "Typ C"

Metall

System adapter for 12 V plug-in contact luminaires

Permissible cable length on secondary side <2m  
Electronic transformer, compatible with "Type C" dimmers

Metal

35-60 VA

Farbe Colour	Artikel Item
Chrom Chrome	31-621-10-05
Chrom matt Matt chrome	31-621-10-06

Kompatible Leuchten: Kapitel PLUG-IN ab Seite 209  
Compatible luminaires: PLUG-IN chapter from page 209



# BEAUTY FREE

## Kronleuchter Chandelier

Design: Ralf Keferstein

BEAUTY FREE ist ein aus den Systemkomponenten des Schienensystems CHECK-IN individuell zusammenstellbares Lichtobjekt: Hier verschmelzen moderne Technik und klassische Formensprache zu einer eleganten Einheit.

Grundsätzlich besteht jedes BEAUTY FREE aus dem Deckengehäuse BASIC mit den Abhängungen, dem Schienenkreis und den Leuchten.

Das Deckengehäuse BASIC eignet sich für Schienenkreise mit einem Durchmesser von 1.100 bis 4.790 Millimetern. Bei der Zusammenstellung der BEAUTY FREE-Komponenten sollte auf eine ausbalancierte Gewichtsverteilung geachtet werden. Gerne übernimmt OLIGO für Sie die individuelle Planung.

BEAUTY FREE is a light object that can be individually assembled from the system components of the CHECK-IN track system: here, modern technology and classic design language merge to form an elegant unit.

Basically, each BEAUTY FREE consists of the BASIC ceiling housing with suspensions, track circuit and luminaires.

The BASIC ceiling housing is suitable for track circuits with a diameter of 1,100 to 4,790 millimetres. When assembling the BEAUTY FREE components, care should be taken to ensure a balanced weight distribution. OLIGO will gladly do the individual planning for you.

# BEAUTY FREE KOMponenten BEAUTY FREE COMPONENTS

Ausgehend vom gewünschten Durchmesser des Schienenkreises ergibt sich die technisch notwendige Anzahl der Abhängungen. Grundsätzlich soll im Verhältnis ein Schienensegment von einer Abhängung getragen werden, so dass die Anzahl der Schienen und Abhängungen immer identisch ist. Abhängig vom Durchmesser des verwendeten Schienenvollkreises ergibt sich die Mindestlänge der Seilabhängung.

The number of suspensions technically required is based on the desired diameter of the track circle. One track segment should always be supported by one suspension, so the number of tracks and suspensions is always identical. The minimum length of the cable suspension is determined depending on the diameter of the full track circle used.

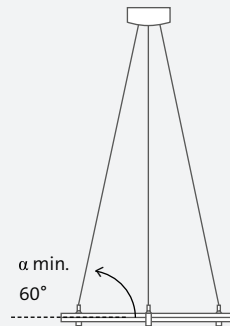

Bitte beachten Sie bei der Planung, dass der Winkel zwischen dem Schienenkreis und der Abhängung nicht kleiner 60° ist.

During planning, please ensure that the angle between the rail circle and the suspension is not smaller than 60°.

## BASIC



Baldachin mit 3 Abhängungen und integrierter Einspeisung

max. 250 V / max. 16 A  
Leitungsquerschnitt 1,5 mm<sup>2</sup>  
Kürzbar  
Metall

Canopy with 3 suspensions and integrated power supply

max. 250 V / max. 16 A  
Cable cross-section 1.5 mm<sup>2</sup>  
Can be shortened  
Metal

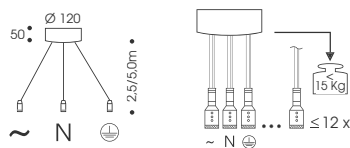

## CIRCLE



Schienenvollkreis, bestehend aus Schienenstücken und Kupplungen

Ø von 1100 bis 2300 mm  
Individuelle Durchmesser siehe Seite 125  
Metall

Full track circle, consisting of track sections and connectors

Ø from 1100 to 2300 mm  
For individual diameters see page 125  
Metal

Farbe Colour	Länge Length	Artikel Item
Chrom matt Matt chrome	3x 2500 mm	31-990-10-06
Chrom matt Matt chrome	3x 5000 mm	31-990-11-06

Farbe Colour	Größe Size	Segmente Sections	Artikel Item
Chrom matt Matt chrome	Ø 1100 mm	3	31-231-10-06
Chrom matt Matt chrome	Ø 1500 mm	4	31-231-11-06
Chrom matt Matt chrome	Ø 1900 mm	5	31-231-12-06
Chrom matt Matt chrome	Ø 2300 mm	6	31-231-13-06

## Beispiel Example



1x BASIC  
1x CIRCLE Ø 1100 mm



Design: Ralf Keferstein

Ø CIRCLE	1100 mm	1500 mm	1900 mm	2300 mm
Benötigte Anzahl BASIC Quantity required	1	1	1	1
Benötigte Anzahl SUSPENSION/2 Quantity required	-	1	2	3
Mindestlänge Seilabhängung Minimum suspension length	750 mm	1100 mm	1450 mm	1800 mm



SUSPENSION / 1



Erweiterungsset für Deckengehäuse BASIC mit 3 Abhängungen und integrierter Einspeisung  
Pro zusätzlichem Schienenkreis CIRCLE wird je ein Erweiterungsset benötigt

Leitungsquerschnitt 1,5 mm<sup>2</sup>  
Kürzbar  
Metall

Extension set for BASIC canopy with 3 suspensions and integrated power supply  
One extension set is required for each additional CIRCLE track circuit

Cable cross-section 1.5 mm<sup>2</sup>  
Can be shortened  
Metal

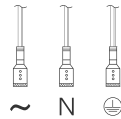

Farbe Colour	Länge Length	Artikel Item
Chrom matt Matt chrome	3x 2500 mm	31-990-20-06
Chrom matt Matt chrome	3x 5000 mm	31-990-21-06

Beispiel Example

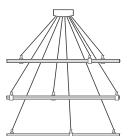

1x BASIC  
2x SUSPENSION/1  
3x CIRCLE Ø 1100 mm

SUSPENSION / 2



Nicht stromführende Abhängung als Erweiterung für Baldachin BASIC  
Benötigt für CIRCLE Ø >1100mm

Leitungsquerschnitt 1,5 mm<sup>2</sup>  
Kürzbar  
Metall

Non-conductive suspension as an expansion for BASIC canopy  
Required for CIRCLE Ø >1100mm

Cable cross-section 1.5 mm<sup>2</sup>  
Can be shortened  
Metal

Farbe Colour	Länge Length	Artikel Item
Chrom matt Matt chrome	1x 2500 mm	31-990-22-06
Chrom matt Matt chrome	1x 5000 mm	31-990-23-06

Beispiele Examples

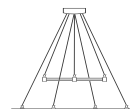

1x BASIC  
1x SUSPENSION/1  
1x SUSPENSION/2  
1x CIRCLE Ø 1100 mm  
1x CIRCLE Ø 1500 mm

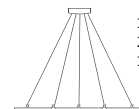

1x BASIC  
2x SUSPENSION/2  
1x CIRCLE Ø 1900 mm

# BEAUTY FREE ANWENDUNGSBEISPIELE

## BEAUTY FREE EXAMPLES OF USE



1x BASIC | 1x CIRCLE Ø 1100 | 6x B TUBE



1x BASIC | 2x SUSPENSION/1 | 3x CIRCLE Ø 1100 | 18x B TUBE

# SYSTEMKOMPONENTEN

## SYSTEM COMPONENTS

Design: Ralf Keferstein

max. 250 V | max. 16 A | Schutzklasse 1  
Protection class 1

Die Komponenten eines Schienensystems variieren je nach Anwendungssituation und individuellen Anforderungen des Kunden. Ein funktionsfähiges System besteht immer aus bestimmten Basiskomponenten.

Die nachfolgende Checkliste erleichtert die Prüfung zur Vollständigkeit des Systems und dient als Leitfaden für die richtige Auswahl der Komponenten.

Beispiele Examples

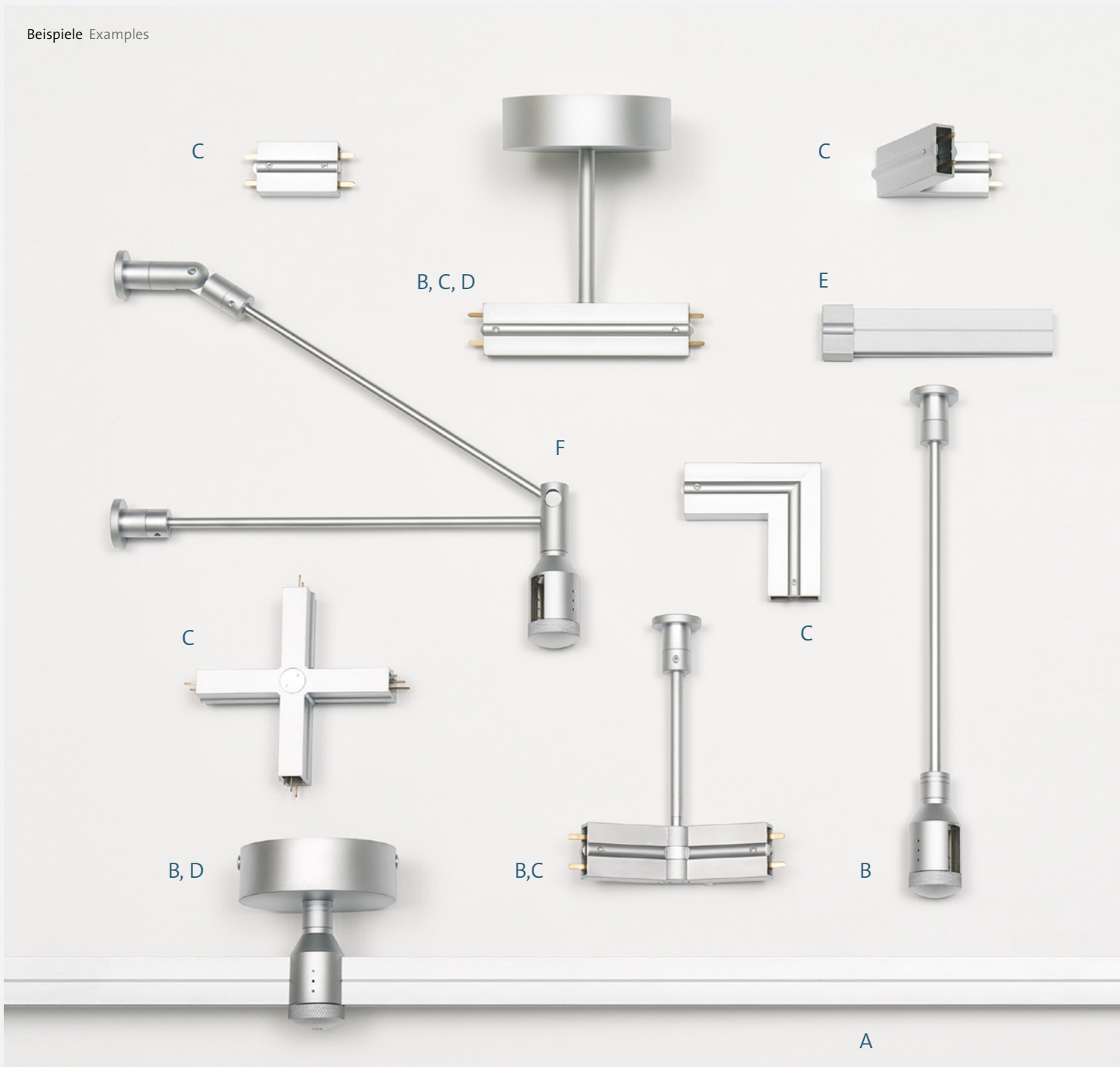

The components in a track system vary according to the situation in which it is used and the customer's individual requirements. A functional system always consists of certain base components.

The following checklist facilitates checking the completeness of the system and serves as a guideline for choosing the right components.



#### CHECKLISTE BASISKOMPONENTEN BASE COMPONENTS CHECKLIST

- A **Stromschiene**  
Track
- B **Träger | Abhängung**  
Support | Suspension
- C **Kupplung**  
Connector
- D **Einspeisung**  
Power supply
- E **Endstücke | Endkappen**  
End piece | End cap

#### SPEZIFISCHE KOMPONENTEN SPECIFIC COMPONENTS

- F **Schienausleger**  
Track arm
- Bildaufhängung**  
Picture mounting

# SYSTEMPLANUNG

Bei der Planung des Schienensystems stehen zwei technisch und gestalterisch unterschiedliche Trägersysteme (TYP A und TYP B) zur Wahl.

# SYSTEM PLANNING

When planning the track system, there is a choice between two technically and stylistically differing support systems (TYPE A and TYPE B).

## SYSTEMTRÄGER TYP A

Träger TYP A basieren auf einer zylindrischen Form. Das Trägersystem ist durch die Funktionstrennung von Schienenträger und Schienenkupplung gekennzeichnet. Die Schiene kann an beliebiger Stelle in den Träger eingehängt werden. Es ist eine separate Kupplung an anderer Stelle erforderlich:

### SYSTEM SUPPORT TYPE A

The TYPE A support system is characterised by the functional separation of track support and track connector. A track can be hung in the support at any point. A separate connection is required at another point:

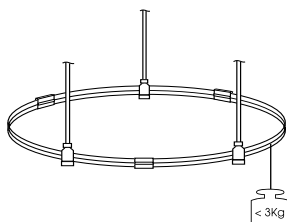
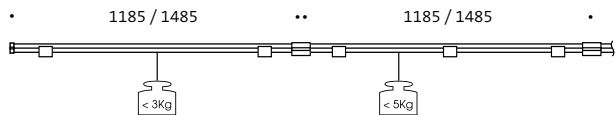
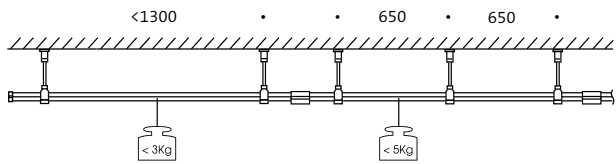
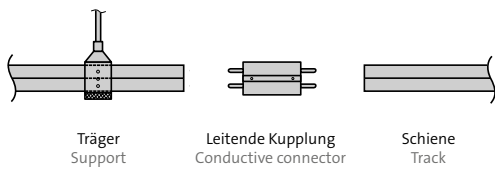

## SYSTEMTRÄGER TYP B

Träger TYP B basieren auf einer Quaderform. Bei System TYP B bilden Träger- und Schienenkupplung eine Einheit. Grundsätzlich sind drei verschiedene Funktionstypen zu unterscheiden:

### SYSTEM SUPPORT TYPE B

For the TYPE B system, the support and track connector form a unit. Fundamentally, they are divided into three different functional types:

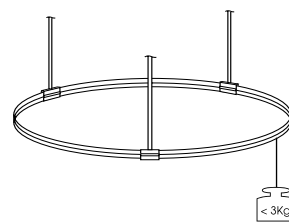
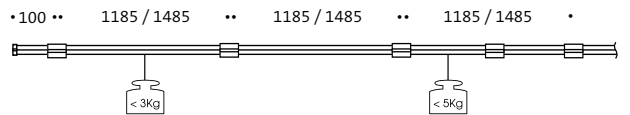
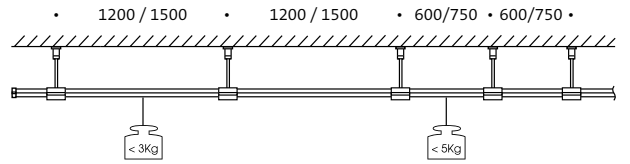
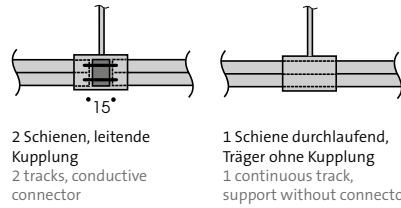

1.1 SCHIENE, GERADE  
STRAIGHT TRACK



22 x 8 mm / 1,5 mm<sup>2</sup>

Kürzbar  
Metall

Can be shortened  
Metal

Farbe Colour	Länge Length	Artikel Item
Chrom Chrome	1185 mm	31-201-10-05
Chrom matt Matt chrome	1185 mm	31-201-10-06
Chrom matt Matt chrome	1485 mm	31-201-11-06

1.2 SCHIENE, GEBOGEN  
CURVED TRACK



Kürzbar  
Metall

Can be shortened  
Metal

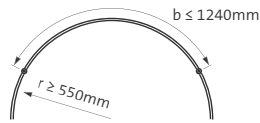

Farbe Colour	Bogenmaß Radian	Artikel Item
Chrom matt Matt chrome	b = 1240 mm	31-211-10-06
Chrom matt Matt chrome	b < 1240 mm	31-211-11-06

1.3 KREIS  
CIRCLE

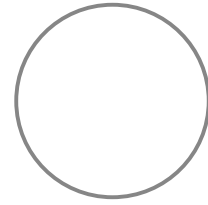

Vollkreis, bestehend aus Schienenstücken  
und Kupplungen  
Metall

Full circle, consisting of track sections and  
connectors  
Metal

Farbe Colour	Ø	Artikel Item
Chrom matt Matt chrome	1100 mm	31-231-10-06
Chrom matt Matt chrome	1500 mm	31-231-11-06
Chrom matt Matt chrome	1900 mm	31-231-12-06
Chrom matt Matt chrome	2300 mm	31-231-13-06

2.1 TRÄGER Ø 14 mm  
SUPPORT Ø 14 mm TYP A  
TYPE A



Metall  
Metal

Farbe Colour	Länge Length	Artikel Item
Chrom Chrome	50 mm	31-301-10-05
Chrom matt Matt chrome		31-301-10-06

2.2 TRÄGER ABDECKSCHEIBE  
SUPPORT COVER DISC TYP A  
TYPE A



Ø 24 x 4 mm

Optionales Zubehör  
Kompatibel: 2.1  
Metall

Optional accessory  
Compatible: 2.1  
Metal

Farbe Colour	Artikel Item
Chrom Chrome	31-311-10-05
Chrom matt Matt chrome	31-311-10-06

2.3 TRÄGER Ø 6 mm  
SUPPORT Ø 6 mm TYP A  
TYPE A



Kürzbar  
Metall

Can be shortened  
Metal

Farbe Colour	Länge Length	Artikel Item
Chrom Chrome	100 mm	31-301-11-05
Chrom matt Matt chrome		31-301-11-06
Chrom Chrome	225 mm	31-301-12-05
Chrom matt Matt chrome		31-301-12-06
Chrom Chrome	525 mm	31-301-13-05
Chrom matt Matt chrome		31-301-13-06

**2.4 SCHIENENAUSLEGER  
TRACK ARM**

**TYP A  
TYPE A**



Wandabstand 200 mm  
Kürzbar  
Metall

Wall distance 200 mm  
Can be shortened  
Metal

**2.5 WANDTRÄGER  
WALL SUPPORT**

**TYP A  
TYPE A**



30 x 26 x 24 mm

Metall  
Metal

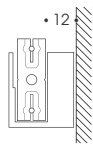

**2.6 ABHÄNGUNG  
SUSPENSION**

**TYP A  
TYPE A**



Kürzbar  
Metall

Can be shortened  
Metal

Farbe Colour	Artikel Item
Chrom matt Matt chrome	31-351-10-06

Farbe Colour	Artikel Item
Chrom matt Matt chrome	31-321-10-06

Farbe Colour	Länge Length	Artikel Item
Chrom Chrome	1500 mm	31-331-10-05
Chrom matt Matt chrome	1500 mm	31-331-10-06

**3.1 I-KUPPLUNG  
I-CONNECTOR**

**TYP A  
TYPE A**



40 x 26 x 12 mm

Metall  
Metal

LEITEND CONDUCTIVE

Farbe Colour	Artikel Item
Chrom Chrome	31-401-10-05
Chrom matt Matt chrome	31-401-10-06

ISOLIEREND INSULATING

Farbe Colour	Artikel Item
Chrom Chrome	31-401-11-05
Chrom matt Matt chrome	31-401-11-06

**3.2 SCHWENKKUPPLUNG  
SWIVEL CONNECTOR**

**TYP A  
TYPE A**



90 x 26 x 12 mm

Schwenkbereich 80 - 180°  
Metall

Swivel range 80 - 180°  
Metal

LEITEND CONDUCTIVE

Farbe Colour	Artikel Item
Chrom Chrome	31-411-10-05
Chrom matt Matt chrome	31-411-10-06

ISOLIEREND INSULATING

Farbe Colour	Artikel Item
Chrom matt Matt chrome	31-411-11-06

**3.3 T-KUPPLUNG  
T-CONNECTOR**

**TYP A  
TYPE A**



90 x 55 x 26 mm

Metall  
Metal

LEITEND CONDUCTIVE

Farbe Colour	Artikel Item
Chrom matt Matt chrome	31-421-10-06



3.4 Y/T-SCHWENKUPPLUNG  
Y/T-SWIVEL CONNECTOR TYP A  
TYPE A



90 x 55 x 26 mm

Metall  
Metal

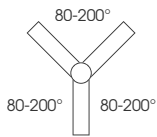

LEITEND CONDUCTIVE

Farbe Colour	Artikel Item
Chrom matt Matt chrome	31-416-10-06

3.5 X-KUPPLUNG  
X-CONNECTOR TYP A  
TYPE A



90 x 90 x 26 mm

Metall  
Metal

LEITEND CONDUCTIVE

Farbe Colour	Artikel Item
Chrom Chrome	31-431-10-05
Chrom matt Matt chrome	31-431-10-06

3.6 V-KUPPLUNG  
V-CONNECTOR TYP A  
TYPE A



Horizontal 60°  
Metall

Horizontal 60°  
Metal

LEITEND CONDUCTIVE

Farbe Colour	Artikel Item
Chrom matt Matt chrome	31-441-10-06

3.6 L-KUPPLUNG  
L-CONNECTOR TYP A  
TYPE A



Vertikal 90°  
Metall

Vertical 90°  
Metal

LEITEND CONDUCTIVE

Farbe Colour	Artikel Item
Chrom matt Matt chrome	31-451-10-06

4. EINSPEISUNG, DECKE  
POWER SUPPLY, CEILING TYP A  
TYPE A



Ø 82 mm

Metall  
Metal

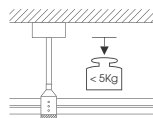

Farbe Colour	Länge Length	Artikel Item
Chrom Chrome	50 mm	31-501-10-05
Chrom matt Matt chrome		31-501-10-06
Chrom Chrome	100 mm	31-501-11-05
Chrom matt Matt chrome		31-501-11-06

Farbe Colour	Länge Length	Artikel Item
Chrom Chrome	225 mm	31-501-12-05
Chrom matt Matt chrome		31-501-12-06
Chrom matt Matt chrome	525 mm	31-501-13-06

5. ENDKAPPE  
END CAP

TYP A  
TYPE A



22 x 8 x 15 mm

Ausführung Transparent zur Kombination mit Schiene in Chrom Polykarbonat

Transparent version for combination with chrome track Polycarbonate

Farbe Colour	Artikel Item
Transparent	31-601-10-01
Chrom matt	31-601-10-06

6.1 TRÄGER  
SUPPORT

TYP B  
TYPE B

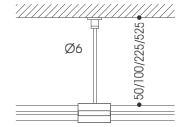

Kürzbar  
Metall

Can be shortened  
Metal

KUPPLUNG, LEITEND CONDUCTIVE CONNECTOR

Farbe Colour	Länge Length	Artikel Item
Chrom Chrome	50 mm	31-302-10-05
Chrom matt Matt chrome		31-302-10-06
Chrom Chrome	100 mm	31-302-11-05
Chrom matt Matt chrome		31-302-11-06
Chrom Chrome	225 mm	31-302-12-05
Chrom matt Matt chrome		31-302-12-06
Chrom matt Matt chrome	525 mm	31-302-13-06

DURCHLAUFEND CONTINUOUS

Farbe Colour	Länge Length	Artikel Item
Chrom Chrome	50 mm	31-302-30-05
Chrom matt Matt chrome		31-302-30-06
Chrom Chrome	100 mm	31-302-31-05
Chrom matt Matt chrome		31-302-31-06
Chrom Chrome	225 mm	31-302-32-05
Chrom matt Matt chrome		31-302-32-06
Chrom matt Matt chrome	525 mm	31-302-33-06

6.2 SCHWENKKUPPLUNG  
SWIVEL CONNECTOR

TYP B  
TYPE B



Kürzbar  
Schwenkbereich 80 - 180°  
Metall

Can be shortened  
Swivel range 80 - 180°  
Metal

LEITEND CONDUCTIVE

Farbe Colour	Länge Length	Artikel Item
Chrom matt Matt chrome	50 mm	31-412-10-06
Chrom Chrome	100 mm	31-412-11-05
Chrom matt Matt chrome		31-412-11-06
Chrom Chrome	225 mm	31-412-12-05
Chrom matt Matt chrome		31-412-12-06
Chrom matt Matt chrome	525 mm	31-412-13-06

6.3 T-KUPPLUNG  
T-CONNECTOR

TYP B  
TYPE B



Kürzbar  
Metall

Can be shortened  
Metal

LEITEND CONDUCTIVE

Farbe Colour	Länge Length	Artikel Item
Chrom matt Matt chrome	50 mm	31-422-10-06
Chrom Chrome	100 mm	31-422-11-05
Chrom matt Matt chrome		31-422-11-06
Chrom Chrome	225 mm	31-422-12-05
Chrom matt Matt chrome		31-422-12-06

6.4 Y/T-SCHWENKKUPPLUNG  
Y/T-SWIVEL CONNECTOR

TYP B  
TYPE B



Kürzbar  
Metall

Can be shortened  
Metal

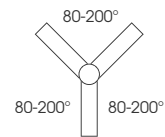

LEITEND CONDUCTIVE

Farbe Colour	Länge Length	Artikel Item
Chrom matt Matt chrome	50 mm	31-414-10-06
Chrom Chrome	100 mm	31-414-11-05
Chrom matt Matt chrome		31-414-11-06
Chrom Chrome	225 mm	31-414-12-05
Chrom matt Matt chrome		31-414-12-06

**6.5 X-KUPPLUNG** TYP B  
X-CONNECTOR TYPE B



Kürzbar  
Metall

Can be shortened  
Metal

LEITEND CONDUCTIVE

Farbe Colour	Länge Length	Artikel Item
Chrom matt Matt chrome	50 mm	31-432-10-06
Chrom Chrome	100 mm	31-432-11-05
Chrom matt Matt chrome		31-432-11-06
Chrom Chrome	225 mm	31-432-12-05
Chrom matt Matt chrome		31-432-12-06

**6.6 SCHIENENAUSLEGER** TYP B  
TRACK ARM TYPE B



Wandabstand 200 mm  
Kürzbar  
Metall

Wall distance 200 mm  
Can be shortened  
Metal

DURCHLAUFEND CONTINUOUS

Farbe Colour	Artikel Item
Chrom matt Matt chrome	31-352-10-06

**6.7 WANDTRÄGER** TYP B  
WALL SUPPORT TYPE B



40 x 26 x 24 mm

Metall  
Metal

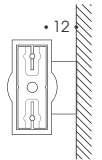

KUPPLUNG, LEITEND CONDUCTIVE CONNECTOR

Farbe Colour	Artikel Item
Chrom Chrome	31-322-10-05
Chrom matt Matt chrome	31-322-10-06

Farbe Colour	Artikel Item
Chrom Chrome	31-322-12-05
Chrom matt Matt chrome	31-322-12-06

**7.1 ABHÄNGUNG** TYP B  
SUSPENSION TYPE B



Kürzbar  
Metall

Can be shortened  
Metal

KUPPLUNG, LEITEND CONDUCTIVE CONNECTOR

Farbe Colour	Länge Length	Artikel Item
Chrom Chrome	1500 mm	31-332-10-05
Chrom matt Matt chrome		31-332-10-06

Farbe Colour	Länge Length	Artikel Item
Chrom matt Matt chrome	1500 mm	31-332-12-06

**7.2 SCHWENKKUPPLUNG, ABH.** TYP B  
SWIVEL CONNECTOR, SUSP. TYPE B



Kürzbar  
Schwenkbereich 80 - 180°  
Metall

Can be shortened  
Swivel range 80 - 180°  
Metal

LEITEND CONDUCTIVE

Farbe Colour	Länge Length	Artikel Item
Chrom matt Matt chrome	1500 mm	31-413-10-06

**7.3 Y/T-SCHWENKKUPPLUNG, ABH.** TYP B  
Y/T-SWIVEL CONNECTOR, SUSP. TYPE B



Kürzbar  
Metall

Can be shortened  
Metal

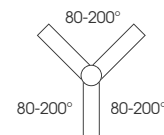

LEITEND CONDUCTIVE

Farbe Colour	Länge Length	Artikel Item
Chrom matt Matt chrome	1500 mm	31-415-10-06

7.4 X-KUPPLUNG, ABHÄNGUNG TYP B  
X-CONNECTOR, SUSPENSION TYPE B



Kürzbar  
Metall

Can be shortened  
Metal

LEITEND CONDUCTIVE

Farbe Colour	Länge Length	Artikel Item
Chrom matt Matt chrome	1500 mm	31-433-10-06

8. EINSPEISUNG, DECKE  
POWER SUPPLY, CEILING

TYP B  
TYPE B



Ø 82 mm

Metall  
Metal

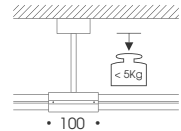

KUPPLUNG, LEITEND CONDUCTIVE CONNECTOR

Farbe Colour	Länge Length	Artikel Item
Chrom Chrome	50 mm	31-502-10-05
Chrom matt Matt chrome		31-502-10-06
Chrom Chrome	100 mm	31-502-11-05
Chrom matt Matt chrome		31-502-11-06

KUPPLUNG, LEITEND CONDUCTIVE CONNECTOR

Farbe Colour	Länge Length	Artikel Item
Chrom Chrome	225 mm	31-502-12-05
Chrom matt Matt chrome		31-502-12-06
Chrom matt Matt chrome	525 mm	31-502-13-06

9. ENDSTÜCK MIT ENDKAPPE TYP B  
END PIECE WITH END CAP TYPE B



22 x 8 x 100 mm

Metall, Polycarbonat  
Metal, polycarbonate

LEITEND CONDUCTIVE

Schiene Track	Endkappe End cap	Artikel Item
Chrom Chrome	Transparent Transparent	31-602-10-05
Chrom matt Matt chrome	Chrom matt Matt chrome	31-602-11-06

10. TRÄGER ZUSATZGELENK  
SUPPORT ADDITIONAL JOINT



Schwenkbereich 90 - 180°  
Kompatibel: 2.3 / 6.1 / 6.2 / 6.3 / 6.4 / 6.5  
Metall

Swivel range 90 - 180°  
Compatible: 2.3 / 6.1 / 6.2 / 6.3 / 6.4 / 6.5  
Metal

Farbe Colour	Artikel Item
Chrom Chrome	62-303-01-05
Chrom matt Matt chrome	62-303-01-06

11. FLEKKUPPLUNG  
FLEXIBLE CONNECTOR



200 mm

Metall  
Metal

LEITEND CONDUCTIVE

Schiene Track	Artikel Item
Chrom matt Matt chrome	31-461-10-06

### 12.1 MITTELEINSPEISUNG, KABEL CENTRAL POWER SUPPLY, CABLE



Ø 82 mm

Bei Ausrichtung nach oben bitte Mindestabstand zur Decke von 70 mm beachten  
Metall

When aligning upwards, please ensure the minimum distance to the ceiling of 70 mm to the ceiling  
Metal

Farbe Colour	Länge Length	Artikel Item
Chrom Chrome	600 mm	31-512-10-05
Chrom matt Matt chrome		31-512-10-06
Chrom Chrome	1600 mm	31-512-11-05
Chrom matt Matt chrome		31-512-11-06

### 12.2 ENDEINSPEISUNG, KABEL END POWER SUPPLY, CABLE



Ø 82 mm

Metall  
Metal

Farbe Colour	Länge Length	Artikel Item
Chrom matt Matt chrome	600 mm	31-512-12-06

### 13.1 ENDEINSPEISUNG, WAND END POWER SUPPLY, WALL



Ø 82 mm

Metall  
Metal

Farbe Colour	Artikel Item
Chrom matt Matt chrome	31-521-10-06

### 13.2 ENDEINSPEISUNG, WAND END POWER SUPPLY, WALL



100 x 30 x 30 mm

Für Galerieschiene  
Metall

For gallery tracks  
Metal

Farbe Colour	Artikel Item
Chrom matt Matt chrome	31-521-11-06

### 14. BILDAUFHÄNGUNG PICTURE MOUNTING



1 Paar  
Metall, Kunststoff

1 pair  
Metal, plastic

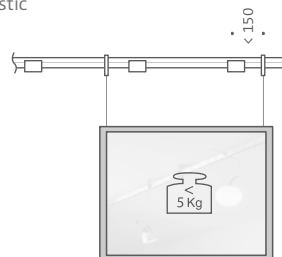

Farbe Colour	Länge Length	Artikel Item
Schwarz Black	1500 mm	62-301-02-23





# PHASE

## 230 V SYSTEM

### LEISTUNGSSTÄRKE IST HIER PROGRAMM

PHASE ist ein dreiphasiges 230 Volt Schienensystem in funktionalem Design. Die hochwertige Aluminium-Profileschiene wird vorzugsweise für geradlinige Lichtkonzepte eingesetzt. Aufgrund der zahlreichen Kombinationsmöglichkeiten für eine gebündelte oder flächige Ausleuchtung zu betonender Flächen und Objekte, empfiehlt sich PHASE insbesondere für den Einsatz im Einzelhandel, in öffentlichen Gebäuden und Konferenzräumen sowie in Galerien und Sakralbauten.

PHASE Systemleuchten werden mit unterschiedlichen Lichttechniken angeboten. Es stehen sowohl LED- als auch Halogenleuchten zur Auswahl.

Über den SMART.POINT- bzw. PLUG-IN-Adapter können sowohl OLIGO Systemleuchten auf 24 Volt Basis, als auch Leuchten auf 12 Volt Basis problemlos in vorhandenen Schienenanlagen im Euroformat verwendet werden.

Durch Einstellung am Adapter werden die Leuchten den einzelnen Stromkreisen zugeordnet und ermöglichen die Konzeption unterschiedlicher Lichtszenen.

Die 24 Volt SMART.POINT Leuchten lassen sich zudem über einen DALI-fähigen Adapter in ein zentral steuerbares Beleuchtungssystem einbinden.

### PERFORMANCE IS THE NAME OF THE GAME HERE

PHASE is a three-phase 230 volt track system with a functional design. The high quality aluminium profile track is primarily used for straight line lighting concepts. Thanks to the multitude of combination possibilities for pooled or flat lighting of surfaces and objects to be highlighted, PHASE is particularly recommended for use in the retail sector, in public buildings and conferences, and in galleries and sacred buildings.

PHASE system luminaires are offered with a variety of lighting technologies. Both LED and halogen luminaires are available to choose from.

Both 24 volt and 12 volt OLIGO system luminaires can be used in existing track systems in the Euro format thanks to the SMART.POINT or PLUG-IN adapter.

Through configuration to the adapter, the luminaires are allocated to the individual circuits and allow for the design of a variety of light scenes.

The 24 volt SMART.POINT luminaires can also be integrated into a centrally controllable lighting system using a DALI-compatible adapter.

# ÜBERSICHT OVERVIEW

## LED

Strahler und  
Raumlichter  
Spots and  
ambient lights



SENTRY  
141



HUBBLE  
141



A LITTLE BIT MORE  
143



A LITTLE BIT  
143



RIDGE  
145



AVIATION  
145



KELVEEN  
147



VERSION B  
147



41 DEGREES  
149



FLAVIA  
149

Pendelleuchten  
Pendant  
luminaires



DECENT  
157



GRACE  
158



A LITTLE BIT  
160



Halogen | Retrofit

Strahler und  
Raumlichter

Spots and  
ambient lights



TWIN LANE  
151



LEVEL  
151



ICE  
152



GATE B SEVEN  
153



HIGH STREAM 16  
155



MX-HIGH  
155



GATE B FOUR  
156

Pendelleuchten

Pendant  
luminaires



PULL-IT 3  
161

PLUG-IN  
Leuchten  
(über Adapter)

PLUG-IN  
luminaires  
(via adapter)



PHASE-IN  
Adapter Adapter 163  
Leuchten Luminaires 209

# PHASE INSTALLATION



LEVEL

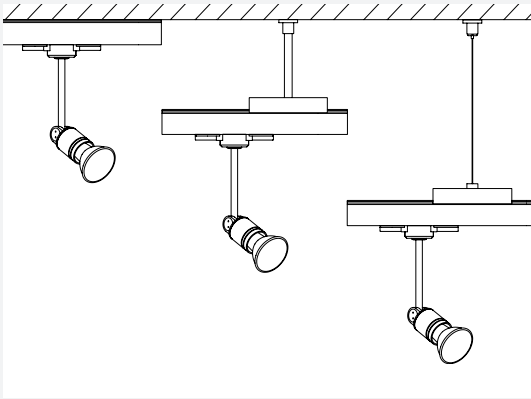

#### Flexible Installationsmöglichkeiten

PHASE kann deckenbündig, mit Distanzträgern und in abgependelter Form installiert werden. Eine bauseitige Längenanpassung kann durch einfaches Sägen vorgenommen werden. Ein Rückschneiden oder Biegen der Kupferleiter ist nicht notwendig. Die Schiene hat vorgestanzte Befestigungs-Länglöcher und ist für den Gebrauch im Handbereich zugelassen.

#### Flexible installation options

PHASE can be installed flush to the ceiling, with a distance support and in suspended form. On-site length adjustment can be done by simple sawing. There is no need to cut back or bend the copper cable. The track has pre-punched mounting slots and is approved for use within arm's reach.

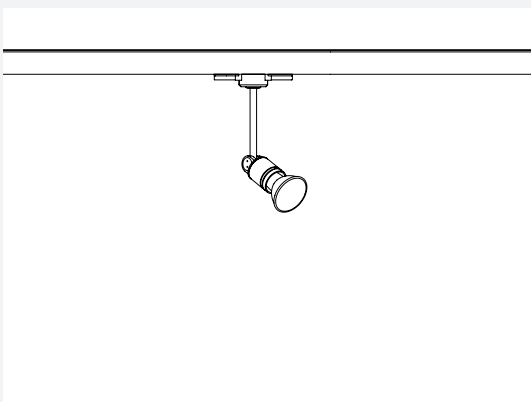

#### Einfach und sicher montieren

PHASE Systemleuchten sind werkseitig fest mit einem universellen Drei-phasen-Adapter versehen. Mittels Klemmbefestigung werden die Leuchten an der Stromschiene befestigt und sind mit wenigen Handgriffen jederzeit neu positionierbar.

#### Install easily and safely

PHASE system luminaires are equipped with a fixed universal three-phase adapter in the factory. The luminaires are attached to the track by means of clamp fastening and can be repositioned in just a few simple steps.

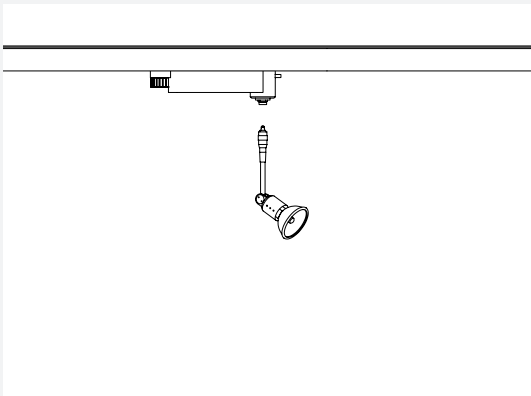

#### Jederzeit erweiterbar

Über einen Systemadapter steht die gesamte Auswahl der 24 Volt SMART.POINT Systemleuchten zur Auswahl. Für die Einbindung dieser Leuchten in ein zentral steuerbares Beleuchtungssystem steht zusätzlich ein Adapter mit DALI-Konverter zur Verfügung.

#### Expandable at any time

The entire range of 24 volt SMART.POINT system luminaires is available for selection by using a system adapter. An adapter with DALI converter is also available for integration of this kind of luminaires into a centrally controllable lighting system.

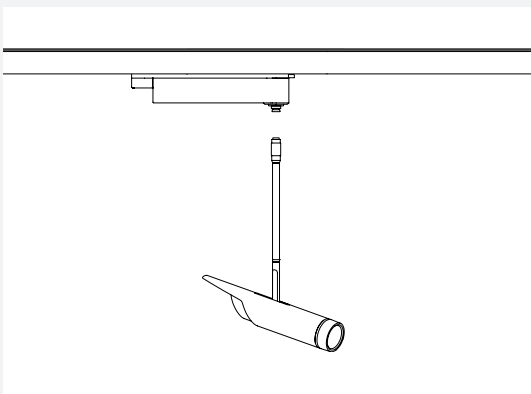

#### Große Leuchtenauswahl

Gleichermaßen lassen sich 12 Volt PLUG-IN Systemleuchten mittels des Adapters PHASE-IN problemlos in das System einfügen.

#### Large selection of luminaires

Likewise, 12 volt PLUG-IN system luminaires can be easily integrated into the system by using the PHASE-IN adapter.

# DIGITALE LICHTSTEUERUNG ÜBER DALI

## DIGITAL LIGHT CONTROL VIA DALI

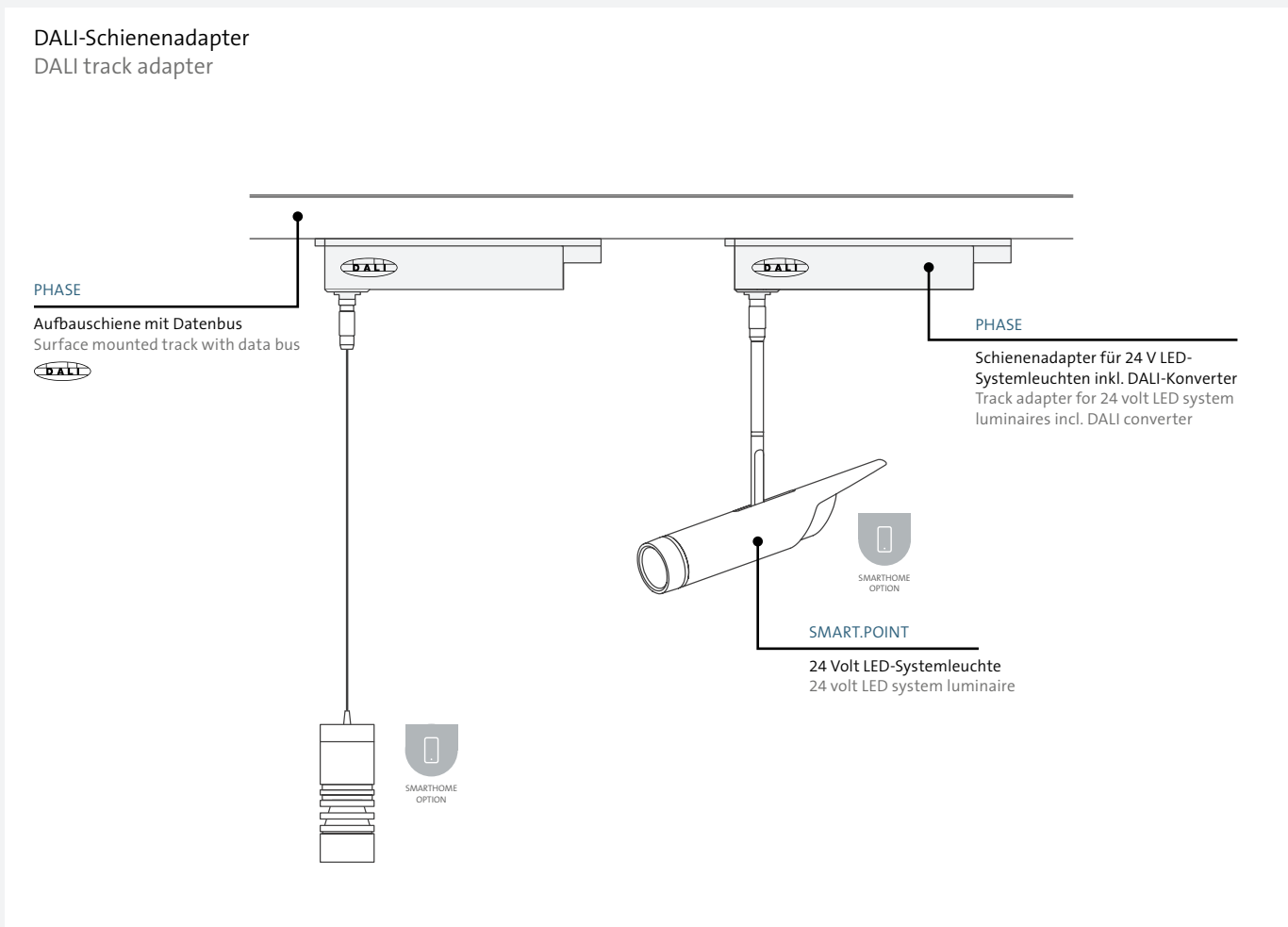

### BEWÄHRTER SCHNITTSTELLENSTANDARD

DALI ist ein praxisbewährter internationaler Schnittstellenstandard für die digitale Lichtsteuerung. Es bietet sich für die professionelle Lichtsteuerung in gewerblichen und öffentlichen Räumen an. Für die Installation genügt eine verpolbare Zweidrahtleitung, die einfach mit der normalen Energieversorgung verlegt werden kann. Der offene Schnittstellenstandard definiert eine bidirektionale Kommunikation zwischen Steuergeräten und bis zu 64 einzeln adressierbaren elektronischen Betriebsgeräten, gleich von welchem Hersteller. Damit ist es möglich, skalierbare Beleuchtungssysteme zu konfigurieren.

### EINBINDUNG IN DIE GEBÄUDETECHNIK

Das System erlaubt umfangreiche Konfigurationsänderungen, ohne nachträglich in die bestehende Elektroinstallation eingreifen zu müssen. Über DALI lassen sich komplexe Lichtinszenierungsebenen realisieren, wie Test-, Status- und Wartungsabfragen. Darüber hinaus ist die Integration des Lichtsteuerungssystems in übergeordnete Gebäudemanagementsysteme möglich.

Ausführliche Informationen über DALI finden Sie unter  
 ☞ [www.dali-ag.org](http://www.dali-ag.org)

### TRIED AND TESTED INTERFACE STANDARD

DALI is a tried and tested international interface standard for digital lighting control. It lends itself to use for professional lighting control in commercial and public spaces. A poleable two-wire cable which can simply be laid with the normal power supply is sufficient for installation. The open interface standard defines bidirectional communication between control units and up to 64 individual addressable electrical operating units, from any manufacturer. It is thus possible to configure scalable lighting systems.

### INTEGRATION INTO BUILDING TECHNOLOGY

The system allows for extensive configuration modifications without having to subsequently interfere with the existing electrical installation. Complex lighting scenarios, such as test, status and maintenance queries, can likewise be realised using DALI. In addition, integration of the lighting control system into higher building management systems is also possible.

Detailed information about DALI can be found at  
 ☞ [www.dali-ag.org](http://www.dali-ag.org)

**DALI Beleuchtungssteuerung**  
DALI lighting control

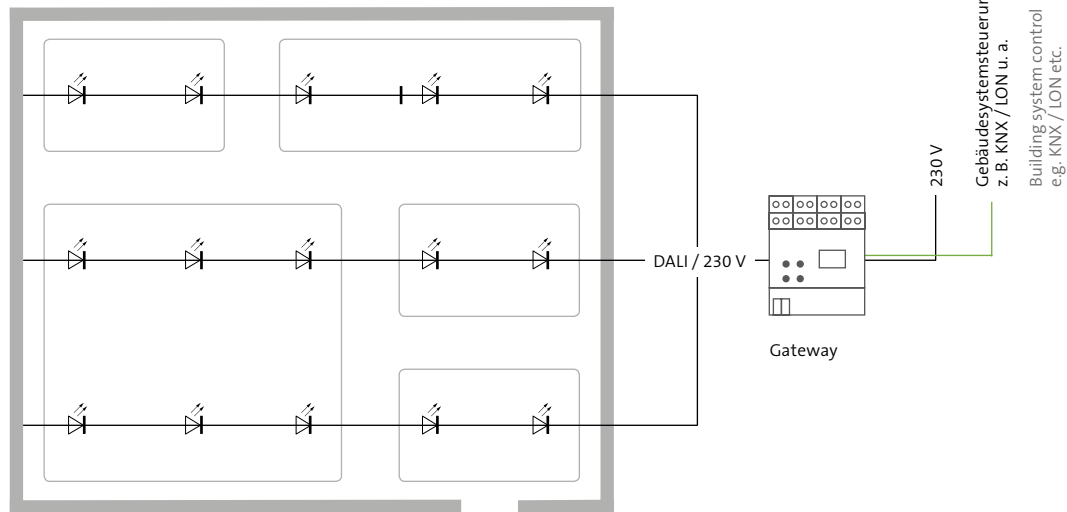

**Geräte für die Lichtsteuerung**  
Devices for lighting control



Tastensensoren  
Touch sensors

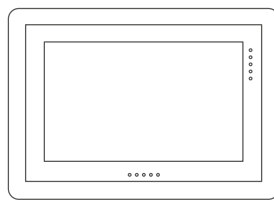

PC oder wandseitig installierte Touch Panel  
PC or touch panel installed on the wall

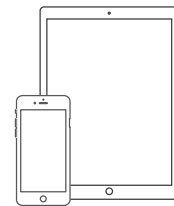

Mobile Endgeräte  
Mobile devices

**FLEXIBLE EINZEL- ODER GRUPPENSTEUERUNG**

24 Volt LED-Systemleuchten mit DALI Schnittstelle sind flexibel adressierbar, d.h. sie können einzeln angesteuert werden, aber auch einer oder mehreren Gruppen angehören. Zusätzlich bieten sie eine deutlich erweiterte Funktionalität, denn sie sind u. a. in der Lage, Informationen für verschiedene Lichtszenen zu speichern, oder Dimmsollwerte zeitgleich mit allen anderen Geräten zu erreichen. Ein entscheidender Vorteil für die Planung ergibt sich durch die Möglichkeit, Lichtgruppen verdrahtungsunabhängig zuzuordnen. In einem Neubau können so bereits alle Leitungen in der Decke verlegt werden, auch wenn die genaue Raumaufteilung noch nicht feststeht. Wird eine Raumaufteilung nachträglich verändert, müssen die Lichtgruppen lediglich im System neu konfiguriert werden.

**LICHTSZENEN**

Mit einem Fingertipp lassen sich vorprogrammierte Lichtstimmungen aufrufen, in denen sich viele verschiedene Leuchten zu einem Gesamtbild ergänzen. Auch Effekte können Bestandteil von Lichtszenen sein, so dass sich nicht nur statische, sondern auch dynamische Lichtstimmungen erzeugen lassen.

**FLEXIBLE INDIVIDUAL OR GROUP CONTROL**

24 volt LED system luminaires with DALI interfaces are flexible, i.e. they can be controlled individually but can also belong to one or more groups. In addition, there is clearly increased functionality since they are able, among other things, to save information for various lighting scenes or reach dimming values at the same time as all other devices. A crucial advantage for planning results from the possibility of assigning light groups independently of the wiring. In a new build, all cables can therefore be laid in the ceiling even if the exact floor plan has not yet been defined. If a floor plan is subsequently changed then the light groups simply need to be reconfigured in the system.

**LIGHT SCENES**

Pre-programmed lighting moods in which many different luminaires complement each other to produce an overall look can be called up with the touch of a finger. Effects can also be part of light scenes, so that not only static but also dynamic lighting moods can be created.



HUBBLE

# SENTRY



Chrom matt  
Matt chrome



Weiß matt  
Matt white



Schwarz matt  
Matt black

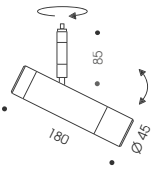

24 V DC 0,7 kg

Strahler

Drehbar, schwenkbar

Aluminium



SMARTHOME  
OPTION

Spotlight

Rotatable, tiltable

Aluminium

LED | 1200 lm | 13,9 W | CRI >90

Leuchte Luminaire	Winkel Angle	2700 K	3000 K
Chrom matt Matt chrome	26°	20-867-60-06	20-867-70-06
	43°	20-867-61-06	20-867-71-06
Weiß matt Matt white	26°	20-867-60-21	20-867-70-21
	43°	20-867-61-21	20-867-71-21
Schwarz matt Matt black	26°	20-867-60-23	20-867-70-23
	43°	20-867-61-23	20-867-71-23

SMART.POINT Adapter separat bestellen auf Seite 163  
Order SMART.POINT adapter separately on page 163

# HUBBLE

Design: Böhler Design



Chrom matt  
Matt chrome



Weiß matt  
Matt white



Schwarz matt  
Matt black

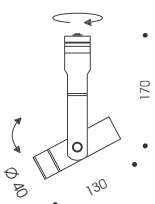

24 V DC 0,8 kg

Strahler

Drehbar, schwenkbar  
Fokussierbarer Lichtaustritt 20-50°

Aluminium



FOKUSSIERT



SMARTHOME  
OPTION

Spotlight

Rotatable, tiltable  
Focusable light emission 20-50°

Aluminium

LED | 900 lm | 10,5 W | 20-50° | CRI >90

Stange Rod	2700 K	3000 K
Chrom matt Matt chrome	20-872-20-06	20-872-30-06
Weiß matt Matt white	20-872-20-21	20-872-30-21
Chrom Chrome	20-872-20-23	20-872-30-23

SMART.POINT Adapter separat bestellen auf Seite 163  
Order SMART.POINT adapter separately on page 163

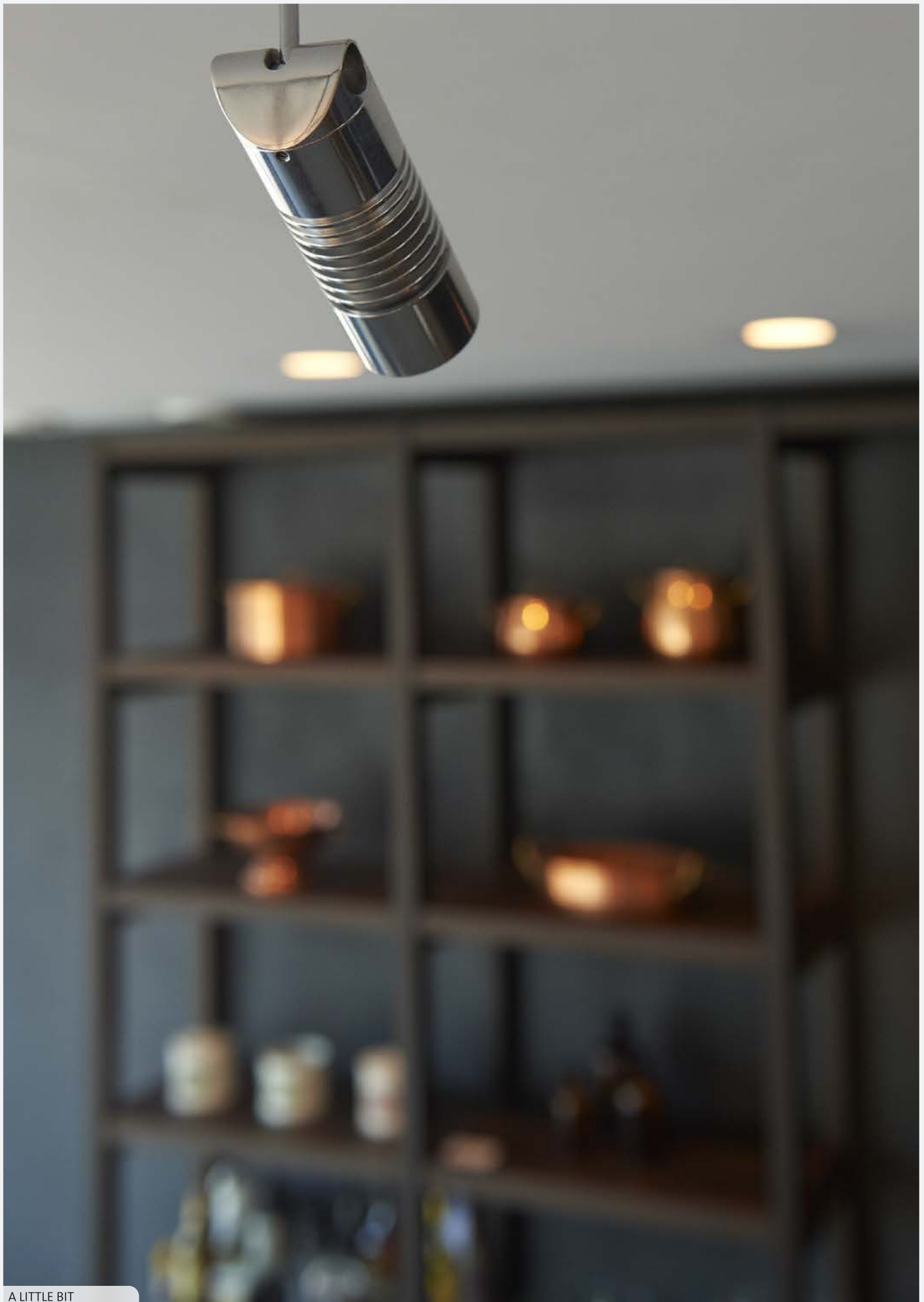

A LITTLE BIT



# A LITTLE BIT MORE



**Strahler**  
 Drehbar, schwenkbar  
 Fokussierbarer Lichtaustritt 20-60°  
**Aluminium, Glas**

Spotlight  
 Rotatable, tiltable  
 Focusable light emission 20-60°  
 Aluminium, glass

LED | 1200 lm | 11 W | 20-60° | CRI >90

Leuchte Luminaire	2700 K	3000 K
<b>Chrom</b> Chrome	20-882-41-05	20-882-51-05
<b>Chrom matt</b> Matt chrome	20-882-42-06	20-882-52-06
<b>Weiß matt</b> Matt white	20-882-43-21	20-882-53-21
<b>Schwarz matt</b> Matt black	20-882-40-23	20-882-50-23

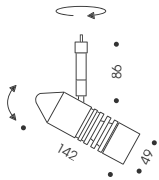

24 V DC 0,6 kg

SMART.POINT Adapter separat bestellen auf Seite 163  
 Order SMART.POINT adapter separately on page 163

# A LITTLE BIT

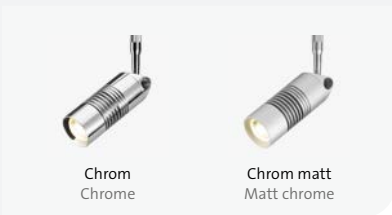

**Strahler**  
 Drehbar, schwenkbar  
 Fokussierbarer Lichtaustritt 20-60°  
**Aluminium, Glas**

Spotlight  
 Rotatable, tiltable  
 Focusable light emission 20-60°  
 Aluminium, glass

LED | 650 lm | 8 W | 20-60° | CRI >90

Leuchte Luminaire	2700 K	3000 K
<b>Chrom</b> Chrome	20-898-40-05	20-898-50-05
<b>Chrom matt</b> Matt chrome	20-898-40-06	20-898-50-06

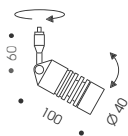

24 V DC 0,2 kg

SMART.POINT Adapter separat bestellen auf Seite 163  
 Order SMART.POINT adapter separately on page 163





# RIDGE



Chrom matt  
Matt chrome



Weiß matt  
Matt white



Schwarz matt, Chrom  
Matt black, Chrome

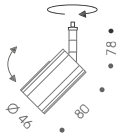

24 V DC 0,2 kg

Strahler

Drehbar, schwenkbar

Aluminium

Spotlight

Rotatable, tiltable

Aluminium

LED | 850 lm | 8 W | 52° | CRI >90

Stange Rod	Korpus Body	2700 K	3000 K
Chrom matt Matt chrome	Chrom matt Matt chrome	20-889-21-06	20-889-31-06
Weiß matt Matt white	Weiß matt Matt white	20-889-22-21	20-889-32-21
Chrom Chrome	Schwarz matt Matt black	20-889-20-23	20-889-30-23

SMART.POINT Adapter separat bestellen auf Seite 163  
Order SMART.POINT adapter separately on page 163

# AVIATION

Design: Böhler Design



Chrom matt  
Matt chrome



Weiß matt  
Matt white



Schwarz matt  
Matt black

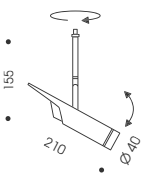

24 V DC 0,5 kg

Strahler

Drehbar, schwenkbar

Aluminium

Spotlight

Rotatable, tiltable

Aluminium

LED | 650 lm | 8,4 W | CRI >90

Leuchte Luminaire	Winkel Angle	2700 K	3000 K
Chrom matt Matt chrome	23°	20-875-60-06	20-875-70-06
	41°	20-875-61-06	20-875-71-06
Weiß matt Matt white	23°	20-875-60-21	20-875-70-21
	41°	20-875-61-21	20-875-71-21
Schwarz matt Matt black	23°	20-875-60-23	20-875-70-23
	41°	20-875-61-23	20-875-71-23

SMART.POINT Adapter separat bestellen auf Seite 163  
Order SMART.POINT adapter separately on page 163



Filter Effekte Filter effects



Rot  
Red



Gelb  
Yellow



Grün  
Green



Blau  
Blue



Magenta  
Magenta

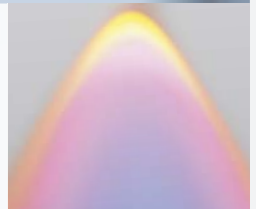

# KELVEEN



Chrom matt  
Matt chrome



Weiß matt  
Matt white



Schwarz matt  
Matt black



SMARTHOME  
OPTION

## Strahler

Drehbar, schwenkbar

KELVEEN Strahler können mit Filtern aus dichroitischem Glas ausgestattet werden. Es entsteht ein mehrfarbiges Lichtspiel.

Aluminium, Thermoplast, Glaslinse

## Spotlight

Rotatable, tiltable

KELVEEN spotlights can be equipped with dichroic glass filters. The result is a multicoloured play of light.

Aluminium, thermoplastic, glass lens

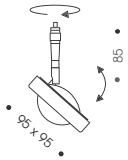

24 V DC 0,4 kg

LED | 1100 lm | 12,5 W | CRI >90

Leuchte Luminaire	Winkel Angle	2700 K	3000 K
Chrom matt Matt chrome	40° 90°	20-869-20-06 20-869-21-06	20-869-30-06 20-869-31-06
Weiß matt Matt white	40° 90°	20-869-20-21 20-869-21-21	20-869-30-21 20-869-31-21
Schwarz matt Matt black	40° 90°	20-869-20-23 20-869-21-23	20-869-30-23 20-869-31-23

SMART.POINT Adapter separat bestellen auf Seite 163  
Order SMART.POINT adapter separately on page 163

## OPTION: FILTER

Farbe Colour	Artikel Item	Farbe Colour	Artikel Item
Rot Red	62-222-10-24	Blau Blue	62-222-10-37
Gelb Yellow	62-222-10-33	Magenta Magenta	62-222-10-46
Grün Green	62-222-10-35		

# VERSION B



Chrom matt  
Matt chrome



Weiß matt  
Matt white



Schwarz matt  
Matt black

## Strahler

Drehbar, schwenkbar  
Schutzglasabdeckung  
Nicht dimmbar  
Handelsware

Aluminium, Glas

## Spotlight

Rotatable, tiltable  
Protective glass cover  
Not dimmable  
Merchandise

Aluminium, Glass

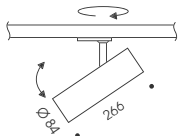

230 V 1,2 kg

LED | 2710 lm | 28 W | CRI >95

Leuchte Luminaire	Winkel Angle	3000 K
Chrom matt Matt chrome	24° 36°	32-854-10-06 32-854-11-06
Weiß matt Matt white	24° 36°	32-854-10-21 32-854-11-21
Schwarz matt Matt black	24° 36°	32-854-10-23 32-854-11-23

Adapter integriert  
Integrated adapter



41 DEGREES

# 41 DEGREES

Design: Ottenwolder und Ottenwolder



Chrom matt  
Matt chrome

Wei matt  
Matt white

Schwarz matt  
Matt black



SMARTHOME  
OPTION

Strahler  
Drehbar, schwenkbar  
Aluminium

Spotlight  
Rotatable, tiltable  
Aluminium

LED | 600 lm | 11 W | CRI >85

Leuchte Luminaire	2700 K	3000 K
Chrom matt Matt chrome	20-871-10-06	20-871-11-06
Wei matt Matt white	20-871-10-21	20-871-11-21
Schwarz matt Matt black	20-871-10-23	20-871-11-23

SMART.POINT Adapter separat bestellen auf Seite 163  
Order SMART.POINT adapter separately on page 163

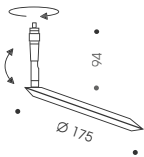

24 V DC 0,3 kg

# FLAVIA

Design: Ottenwolder und Ottenwolder



Chrom matt  
Matt chrome

Wei matt  
Matt white

Schwarz matt  
Matt black

Geschlossen  
Closed

Transluzent  
Translucent

Raumlicht  
Drehbar, schwenkbar  
Nicht dimmbar  
Aluminium

Spotlight  
Rotatable, tiltable  
Not dimmable  
Aluminium

LED | 4,8 W | CRI >85

Prismatik Prism	Lumen Lumen	Lichtfarbe Lightcolour	Chrom matt Matt chrome	Wei matt Matt white	Schwarz matt Matt black
Offen Open	150	2700 K	20-870-10-06	20-870-10-21	20-870-10-23
		3000 K	20-870-12-06	20-870-12-21	20-870-12-23
Geschlossen Closed	200	2700 K	20-870-11-06	20-870-11-21	20-870-11-23
		3000 K	20-870-13-06	20-870-13-21	20-870-13-23
Transluzent Translucent	100	2700 K	20-870-18-06	20-870-18-21	20-870-18-23
		3000 K	20-870-19-06	20-870-19-21	20-870-19-23

SMART.POINT Adapter separat bestellen auf Seite 163  
Order SMART.POINT adapter separately on page 163

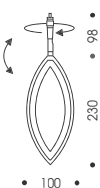

24 V DC 0,2 kg



LEVEL





EXTERN  
DIMMBAR



FÜR RETROFIT  
GEEIGNET

PHASE

## TWIN LANE



Chrom matt  
Matt chrome



Weiß matt  
Matt white

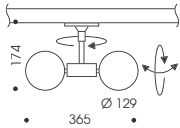

230 V 0,8 kg

Strahler

Drehbar / Leuchtenköpfe kardanisch

Aluminium

Spotlight

Rotatable / Gimbal-mounted luminaire heads

Aluminium

GZ 10 | QPAR 111 Halogen max. 2x 75 W | Retrofit

Leuchte Luminaire	Artikel Item
Chrom matt Matt chrome	32-866-10-06
Weiß matt Matt white	32-866-11-21

Adapter integriert  
Integrated adapter

## LEVEL

Design: Ralf Keferstein



Chrom matt  
Matt chrome



Weiß matt  
Matt white

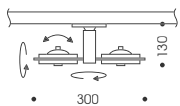

230 V 0,5 kg

Strahler

Drehbar / Leuchtenköpfe kardanisch

Aluminium

Spotlight

Rotatable / Gimbal-mounted luminaire heads

Aluminium

GZ 10 | QPAR 111 Halogen max. 2x 75 W | Retrofit

Leuchte Luminaire	Artikel Item
Chrom matt Matt chrome	32-905-22-06
Weiß matt Matt white	32-905-23-21

Adapter integriert  
Integrated adapter



EXTERN  
DIMMBAR



FÜR RETROFIT  
GEEIGNET

# ICE

Design: Ralf Keferstein

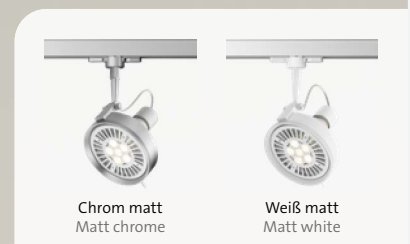

Strahler  
Drehbar, schwenkbar  
Aluminium

Spotlight  
Rotatable, tiltable  
Aluminium

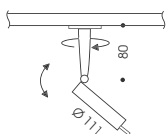

230 V 0,4 kg

GZ 10 | QPAR 111 Halogen max. 75 W | Retrofit

Leuchte Luminaire	Artikel Item
Chrom matt Matt chrome	32-916-10-06
Weiß matt Matt white	32-916-11-21
Adapter integriert Integrated adapter	



EXTERN  
DIMMBAR



FÜR RETROFIT  
GEEIGNET

PHASE

# GATE B SEVEN

Design: Ralf Keferstein



Chrom matt  
Matt chrome

Ring R2  
R2 ring

Schirm S2  
S2 shade

Strahler

Drehbar, schwenkbar

Aluminium

Spotlight

Rotatable, tiltable

Aluminium

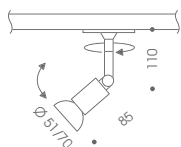

230 V 0,2 kg

GZ 10 | QPAR 51/64 Halogen max. 50/75 W | Retrofit

Adapter Adapter	Korpus Body	Artikel Item
Chrom matt Matt chrome	Chrom matt Matt chrome	32-973-10-06
Weiß matt Matt white	Chrom matt Matt chrome	32-973-11-06

Adapter integriert, Leuchtmittelzubehör ab Seite 244  
Integrated adapter, lamp accessories from page 244



HIGH STREAM 16 | GRACE



EXTERN  
DIMMBAR



FÜR RETROFIT  
GEEIGNET

PHASE

# HIGH STREAM 16

Design: Ralf Keferstein



Strahler

Drehbar, schwenkbar  
Halogen: "Cool beam" nicht zulässig  
Retrofit: Gesamtlänge ≤52 mm empfohlen

Metall

Spotlight

Rotatable, tiltable  
Halogen: "Cool beam" not permitted  
Retrofit: total length ≤52 mm recommended

Metal

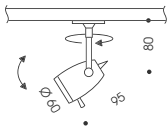

230 V 0,2 kg

GZ 10 | QPAR 51 Halogen max. 50 W | Retrofit

Leuchte Luminaire	Artikel Item
Chrom matt Matt chrome	32-968-10-06
Adapter integriert Integrated adapter	

# MX-HIGH

Design: Ralf Keferstein



Ring R2  
R2 ring

Schirm S2  
S2 shade

Schirm Ø 100  
Shade Ø 100

Strahler

Spotlight

Drehbar, schwenkbar

Rotatable, tiltable

Metall

Metal

GZ 10 | QPAR 51 Halogen max. 50 W | Retrofit

Adapter Adapter	Korpus Body	Artikel Item
Chrom matt Matt chrome	Chrom matt Matt chrome	32-958-10-06
Weiß matt Matt white	Chrom matt Matt chrome	32-958-20-06

Adapter integriert, Zubehör Schirm Ø 100 siehe unten, weiteres Zubehör auf Seite 244  
Integrated adapter, shade Ø 100 accessory see below, further accessories on page 244

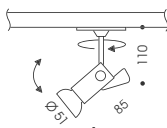

230 V 0,5 kg

OPTION

Typ Type	Material Material	Farbe Colour	Artikel Item
Schirm Ø 100 mm Shade Ø 100 mm	Metall Metal	Chrom matt Matt chrome	62-214-10-06
	Glas Glass	Weiß matt Matt white	62-214-10-21

# GATE B FOUR

Design: Ralf Keferstein



Raumlicht (G 9) oder Strahler (GZ10)

Drehbar, schwenkbar  
Version GZ 10 optional ohne Schirm nutzbar

Aluminium, Glas mundgeblasen

Ambient light (G 9) or spotlight (GZ10)

Rotatable, tilttable  
Version GZ 10 optionally usable without shade

Aluminium, hand-blown glass

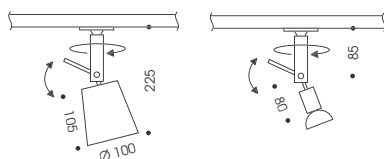

230 V 0,6 kg

230 V 0,2 kg

G 9 | QT-14 Halogen max. 75 W | Retrofit

GZ 10 | QPAR 51/64 Halogen max. 50/75 W | Retrofit

Adapter	Adapter	Korpus Body	G 9	GZ 10
Chrom matt Matt chrome	Chrom matt Matt chrome		32-904-20-06	32-904-10-06
Weiß matt Matt white	Chrom matt Matt chrome		32-904-21-06	32-904-11-06

Adapter integriert, Schirm separat bestellen, weiteres Zubehör (GZ 10) auf Seite 244  
Integrated adapter, order shade separately, further accessories (GZ 10) on page 244

G 9 Schirm G 9 shade		GZ 10 Schirm GZ 10 shade	
Farbe Colour	Artikel Item	Farbe Colour	Artikel Item
Weiß matt Matt white	94-904-10-21	Transparent Transparent	94-904-10-01
Champagner Champagne	94-904-10-42		



GESTEN-  
STEUERUNG



CASAMBI  
ON BOARD



TUNABLE  
WHITE



MESH  
CONTROL

# DECENT



## Pendelleuchte

Kürzbar  
Abhängung auf Anfrage bis 5 m erhältlich  
Nicht über DALI steuerbar

Metall, Kunstglas

## Pendant luminaire

Can be shortened  
Suspension available up to 5 m on request  
Cannot be controlled via DALI

Metal, sythetic glass

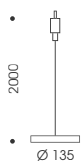

24 V DC 0,5 kg

LED | 2200-5000 K | 800 lm | 11 W | CRI >90

Leuchte Luminaire	Artikel
Chrom Chrome	G20-885-12-05
Aluminium gebürstet Brushed aluminium	G20-885-12-12
Weiß matt Matt white	G20-885-12-21

SMART.POINT Adapter separat bestellen auf Seite 163  
Order SMART.POINT adapter separately on page 163

# GRACE

Design: Ralf Keferstein







GESTEN-  
STEUERUNG



CASAMBI  
ON BOARD



LICHTANTEILE  
UP / DOWN  
STEUERBAR



TUNABLE  
WHITE



MESH  
CONTROL

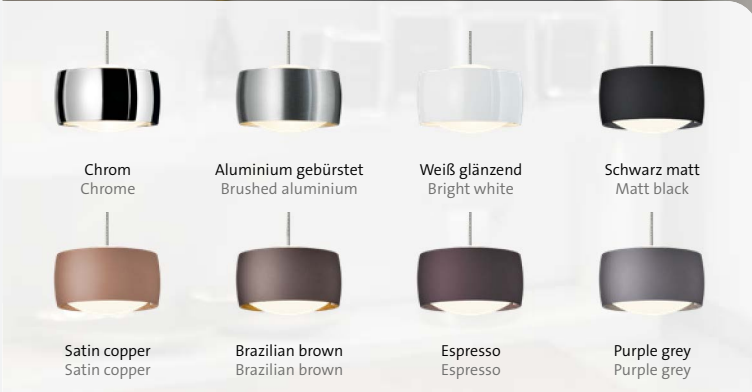

Chrom  
Chrome



Aluminium gebürstet  
Brushed aluminium



Weiß glänzend  
Bright white



Schwarz matt  
Matt black



Satin copper  
Satin copper



Brazilian brown  
Brazilian brown



Espresso  
Espresso



Purple grey  
Purple grey

### Pendelleuchte

#### Kürzbar

Abhängung auf Anfrage bis 5 m erhältlich

Nicht über DALI steuerbar

Metall, Glas

Pendant luminaire

Can be shortened

Suspension available up to 5 m on request

Cannot be controlled via DALI

Metal, glass

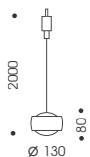

24 V DC 0,8 kg

LED | 2200-5000 K | 1150 lm | 22 W | CRI >90

Leuchte Luminaire	Artikel Item
Chrom Chrome	G20-931-41-05
Aluminium gebürstet Brushed aluminium	G20-931-41-12
Weiß glänzend Bright white	G20-931-41-20
Schwarz matt Matt black	G20-931-41-23
Satin copper Satin copper	G20-931-41-15
Brazilian brown Brazilian brown	G20-931-41-41
Espresso Espresso	G20-931-41-48
Purple grey Purple grey	G20-931-41-49

SMART.POINT Adapter separat bestellen auf Seite 163  
Order SMART.POINT adapter separately on page 163

# A LITTLE BIT



Chrom  
Chrome



Chrom matt  
Matt chrome

### Pendelleuchte

Bitte die gewünschte Gesamtlänge angeben, bauseits nicht kürzbar  
 Abhängung auf Anfrage bis 5 m erhältlich  
 Fokussierbarer Lichtaustritt 20-60°

Bei Einbindung der Leuchte in eine Smarthome Steuerung wird die Funktion  
 des Dimmtasters deaktiviert

Aluminium, Glas

### Pendant luminaire

Please state total length required, cannot be shortened on site  
 Suspension available up to 5 m on request  
 Focusable light emission 20-60°

When the luminaire is integrated into a smarthome control system, the  
 function of the dimmer switch is deactivated

Aluminium, glass

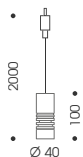

24 V DC 0,2 kg

LED | 650 lm | 8 W | 20-60° | CRI >90

Leuchte Luminaire	2700 K	3000 K
Chrom Chrome	20-898-20-05	20-898-30-05
Chrom matt Matt chrome	20-898-20-06	20-898-30-06

SMART.POINT Adapter separat bestellen auf Seite 163  
 Order SMART.POINT adapter separately on page 163



EXTERN  
DIMMBAR



FÜR RETROFIT  
GEEIGNET

PHASE

# PULL-IT 3

Design: Ralf Keferstein

Lichtplanung, Foto: ArtdLight



Transparent  
Transparent

Weiß matt  
Matt white

Pendelleuchte

Kürzbar

Abhängung auf Anfrage bis 5 m erhältlich

Aluminium, Glas

Pendant luminaire

Can be shortened

Suspension available up to 5 m on request

Aluminium, glass

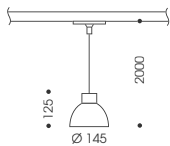

230 V 0,7 kg

G 9 | QT 14 Halogen max. 60 W | Retrofit

Adapter Adapter	Leuchte Luminaire	Artikel Item
Chrom matt Matt chrome	Transparent Transparent	32-952-10-06/01
Chrom matt Matt chrome	Weiß matt Matt white	32-952-10-06/21

Adapter integriert  
Integrated adapter



BENE

# 24 V DC SMART.POINT ADAPTER



Kompatibel mit (Beispiele) Compatible with (Examples)



SENTRY  
141



41 DEGREES  
149



DECENT  
157

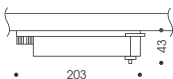

230 V | 50-60 Hz | 24 V 0,3 kg

Systemadapter für 24 V DC SMART.POINT Steckkontaktleuchten

Schaltnetzteil  
Optional mit integriertem DALI Konverter (nur für Leuchten mit Smarthome Option, stromführende Komponenten müssen Datenbus besitzen)

Kunststoff

System adapter for 24 V DC SMART.POINT plug-in contact luminaires

Switch-mode power supply  
Optionally with integrated DALI converter (only for luminaires with Smart-home option, current-carrying components must have data bus)

Plastic

36 VA

Farbe Colour	Standard	DALI
Chrom matt Matt chrome	33-624-10-06	D33-624-10-06
Weiß matt Matt white	33-624-10-21	D33-624-10-21
Schwarz matt Matt black	33-624-10-23	D33-624-10-23

Kompatibel mit 24 V DC LED Steckkontaktleuchten aus diesem Kapitel  
Compatible with 24 V DC LED plug-in contact luminaires from this chapter

# PHASE-IN

Design: Ralf Keferstein



Kompatibel mit (Beispiele) Compatible with (Examples)



CHARLES  
221



BALINO  
225



BENE  
226

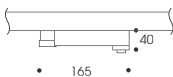

230 V | 50-60 Hz | 12 V 0,2 kg

Systemadapter für 12 V Steckkontaktleuchten

Sekundärseitig zulässige Leitungslänge <2m  
Elektronischer Transformator, kompatibel mit Dimmer "Typ C"

Kunststoff

System adapter for 12 V plug-in contact luminaires

Permissible cable length on secondary side <2m  
Electronic transformer, compatible with "Type C" dimmers

Plastic

20-50 VA

Farbe Colour	Artikel Item
Chrom matt Matt chrome	33-621-10-06
Weiß matt Matt white	33-621-10-21

Kompatible Leuchten: Kapitel PLUG-IN ab Seite 208  
Compatible luminaires: PLUG-IN chapter from page 208

# SYSTEMKOMPONENTEN SYSTEM COMPONENTS

230 V | 1x max. 16 A | 400 V | 3x max. 16 A

Schutzklasse 1  
Protection class 1

Die Komponenten eines Schienensystems variieren je nach Anwendungssituation und individuellen Anforderungen des Kunden. Ein funktionsfähiges System besteht immer aus bestimmten Basiskomponenten.

Die nachfolgende Checkliste erleichtert die Prüfung zur Vollständigkeit des Systems und dient als Leitfaden für die richtige Auswahl der Komponenten.

Beispiele Examples

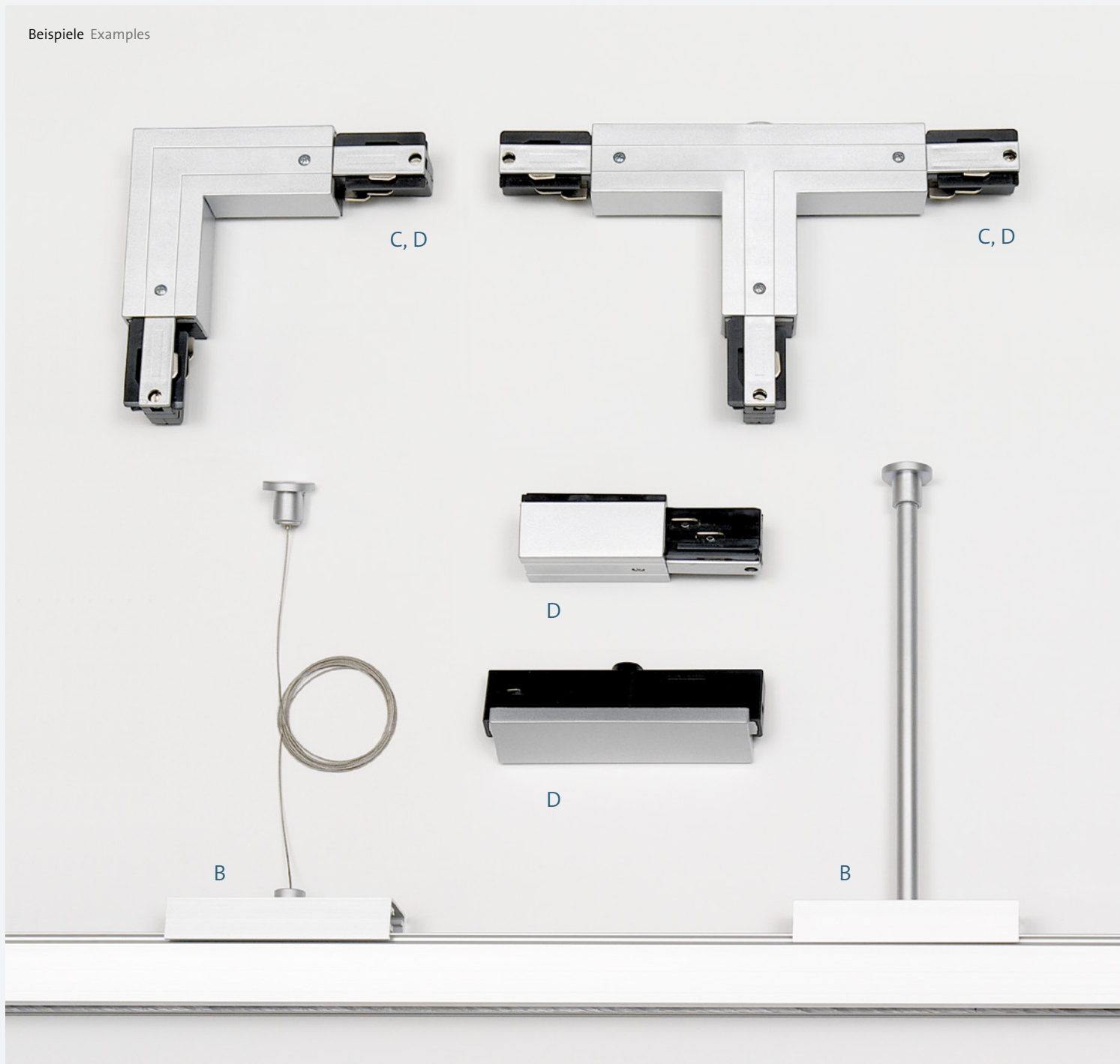

The components in a track system vary according to the situation in which it is used and the customer's individual requirements. A functional system always consists of certain base components.

The following checklist facilitates checking the completeness of the system and serves as a guideline for choosing the right components

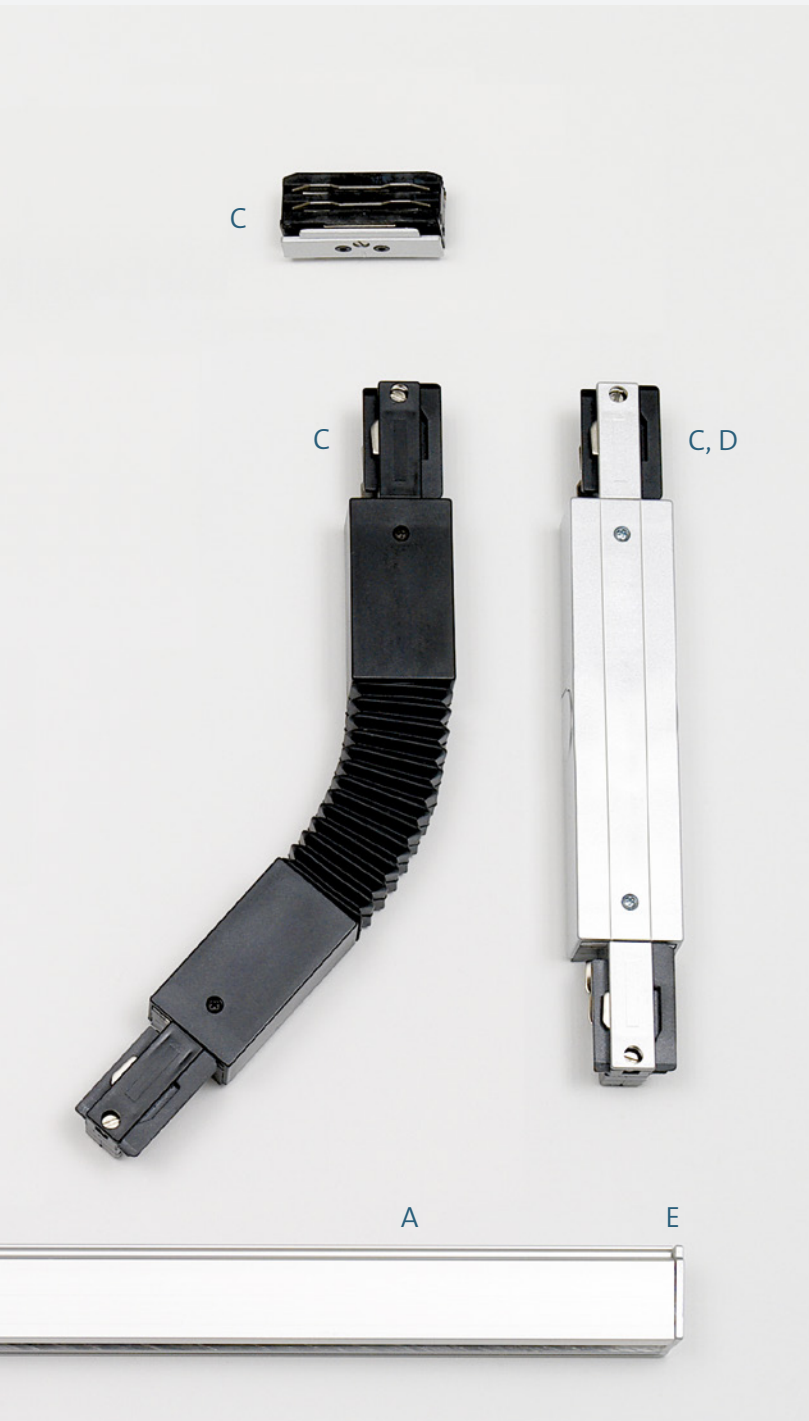

**CHECKLISTE BASISKOMPONENTEN**  
CHECKLIST BASIC COMPONENTS

- A **Stromschiene**  
Track
- B **Träger | Abhängung**  
Support | Suspension
- C **Kupplung**  
Coupler
- D **Einspeisung**  
Feed
- E **Endstücke | Endkappen**  
End piece | End cap

**DISTANZEN UND GEWICHTE**  
DISTANCES AND WEIGHTS

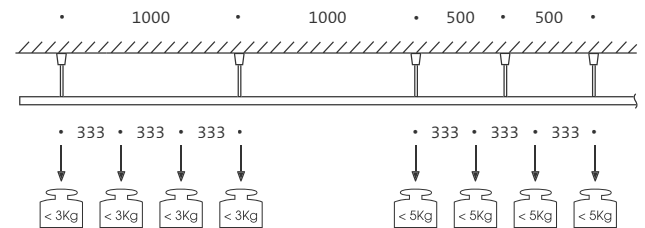

**PROFILSCHNITT**  
PROFILE CUT

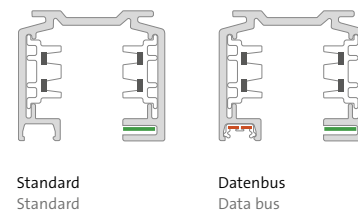

# PHASE

## INSTALLATIONSBEISPIEL MIT DATENBUS

## INSTALLATION EXAMPLE WITH DATA BUS

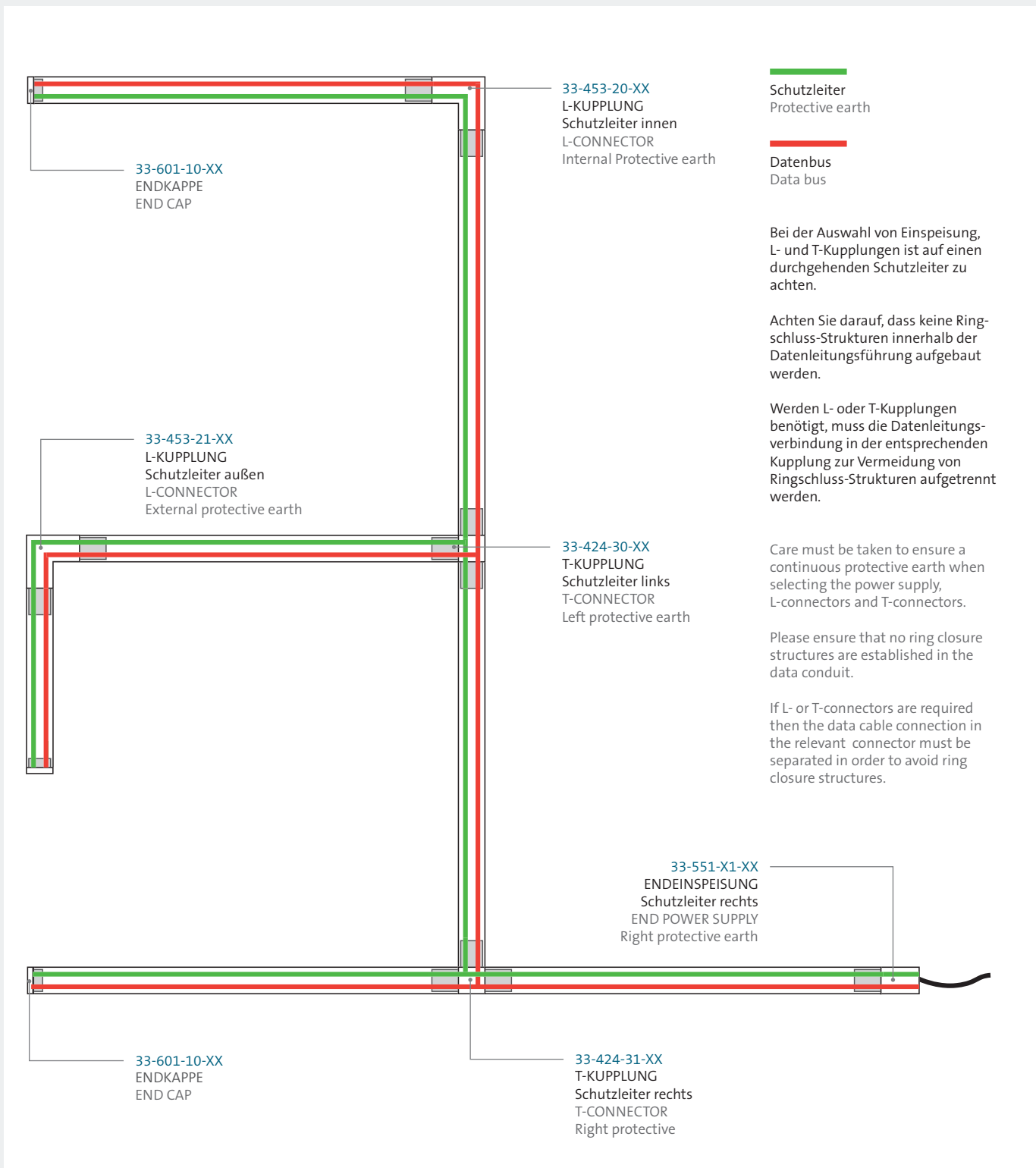



## DATENBUS OPTION

Bitte achten Sie bei der Planung einer DALI-Installation auf eine durchgängige Ausstattung der stromführenden Komponenten mit Datenbus.

Datenleitung nur für Schutzkleinspannung (SELV) ~ max. 50 V / 2 A

## DATA BUS OPTION

When planning a DALI installation, please ensure that all current-carrying components are equipped with a data bus.

Data line only for safety extra-low voltage (SELV) ~ max. 50 V / 2 A

### 1.1 SCHIENE TRACK



36 x 32 mm / 2,5 mm<sup>2</sup>

Kürzbar  
Weitere Schienenfarben auf Anfrage  
Metall

Can be shortened  
Other track colours on request  
Metal

#### STANDARD

Farbe Colour	Länge Length	Artikel Item
Chrom matt Matt chrome	2000 mm	33-201-10-06
Weiß matt Matt white		33-201-10-21
Chrom matt Matt chrome	3000 mm	33-201-20-06
Weiß matt Matt white		33-201-20-21

#### DATA BUS

Farbe Colour	Länge Length	Artikel Item
Chrom matt Matt chrome	2000 mm	33-201-11-06
Weiß matt Matt white		33-201-11-21
Chrom matt Matt chrome	3000 mm	33-201-21-06
Weiß matt Matt white		33-201-21-21

### 2.1 DECKENCLIP / VERBINDER CEILING CLIP / CONNECTOR



100 x 36 x 19 mm

Für Deckenanbaumontage oder als Stoßstellenverbinder  
Metall

For ceiling surface mounting or as joint connector  
Metal



Farbe Colour	Länge Length	Artikel Item
Chrom matt Matt chrome	10 mm	33-301-10-06
Weiß matt Matt white		33-301-10-21

### 2.2 TRÄGER SUPPORT



100 x 36 x 19 mm / Ø 10 mm

Metall  
Metal

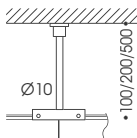

Farbe Colour	Länge Length	Artikel Item
Chrom matt Matt chrome	100 mm	33-301-11-06
Weiß matt Matt white		33-301-11-21
Chrom matt Matt chrome	200 mm	33-301-12-06
Weiß matt Matt white		33-301-12-21

Farbe Colour	Länge Length	Artikel Item
Chrom matt Matt chrome	500 mm	33-301-13-06
Weiß matt Matt white		33-301-13-21

3. SEILABHÄNGUNG  
SUSPENSION



Kürzbar  
Metall

Can be shortened  
Metal

Farbe Colour	Länge Length	Artikel Item
Chrom matt Matt chrome	1500 mm	33-331-10-06
Weiß matt Matt white		33-331-10-21

4. KUPPLUNG  
CONNECTOR



62 x 25 mm

Innenliegend, bei Seilabhangung mit Sto-  
stellenverbinder (2.1) kombinieren oder  
I-Kupplung (5.2) verwenden  
Kunststoff

Internal, combine with joint connector (2.1)  
or use I-connector (5.2) for cable suspension  
Plastic

STANDARD / DATA BUS

Farbe Colour	Typ Type	Artikel Item
Chrom matt Matt chrome	Standard	33-401-10-06
Weiß matt Matt white		33-401-10-21
Chrom matt Matt chrome	Data bus	33-401-11-06
Weiß matt Matt white		33-401-11-21

5.1 FLEKKUPPLUNG + EINSPEISUNG  
FLEXIBLE CONNECTOR + POWER SUPPLY



30° - 330°

Kunststoff  
Plastic

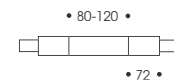

STANDARD / DATA BUS

Farbe Colour	Typ Type	Artikel Item
Weiß matt Matt white	Standard	33-461-10-21
Schwarz matt Matt black		33-461-10-23
Weiß matt Matt white	Data bus	33-461-11-21
Schwarz matt Matt black		33-461-11-23

5.2 I-KUPPLUNG + EINSPEISUNG  
I-CONNECTOR + POWER SUPPLY



Kunststoff  
Plastic



STANDARD / DATA BUS

Farbe Colour	Typ Type	Artikel Item
Chrom matt Matt chrome	Standard	33-404-10-06
Weiß matt Matt white		33-404-10-21
Chrom matt Matt chrome	Data bus	33-404-12-06
Weiß matt Matt white		33-404-12-21

5.3 L-KUPPLUNG + EINSPEISUNG  
L-CONNECTOR + POWER SUPPLY



Kunststoff  
Plastic

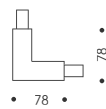

SCHUTZLEITER INNEN  
INTERNAL PROTECTIVE EARTH



Farbe Colour	Typ Type	Artikel Item
Chrom matt Matt chrome	Standard	33-453-10-06
Weiß matt Matt white		33-453-10-21
Chrom matt Matt chrome	Data bus	33-453-20-06
Weiß matt Matt white		33-453-20-21

SCHUTZLEITER AUSSEN  
EXTERNAL PROTECTIVE EARTH



Farbe Colour	Typ Type	Artikel Item
Chrom matt Matt chrome	Standard	33-453-11-06
Weiß matt Matt white		33-453-11-21
Chrom matt Matt chrome	Data bus	33-453-21-06
Weiß matt Matt white		33-453-21-21

5.4 T-KUPPLUNG + EINSPEISUNG  
T-CONNECTOR + POWER SUPPLY



Kunststoff  
Plastic

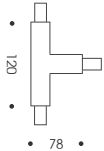

SCHUTZLEITER LINKS  
LEFT PROTECTIVE EARTH



Farbe Colour	Typ Type	Artikel Item
Chrom matt Matt chrome	Standard	33-424-10-06
Weiß matt Matt white		33-424-10-21
Chrom matt Matt chrome	Data bus	33-424-30-06
Weiß matt Matt white		33-424-30-21

SCHUTZLEITER RECHTS  
RIGHT PROTECTIVE EARTH



Farbe Colour	Typ Type	Artikel Item
Chrom matt Matt chrome	Standard	33-453-11-06
Weiß matt Matt white		33-453-11-21
Chrom matt Matt chrome	Data bus	33-453-31-06
Weiß matt Matt white		33-453-31-21

6. ABDECKPROFIL / ENDKAPPE  
COVER PROFILE / END CAP



Kunststoff  
Plastic

ABDECKPROFIL COVER PROFILE

Farbe Colour	Länge Length	Artikel Item
Weiß matt Matt white	1000 mm	33-651-10-21

ENDKAPPE END CAP

Farbe Colour	Artikel Item
Chrom matt Matt chrome	33-601-10-06
Weiß matt Matt white	33-601-10-21

7.1 ENDEINSPEISUNG  
END POWER SUPPLY



72 x 36 x 36 mm

Kunststoff  
Plastic



SCHUTZLEITER LINKS  
LEFT PROTECTIVE EARTH



Farbe Colour	Typ Type	Artikel Item
Chrom matt Matt chrome	Standard	33-551-10-06
Weiß matt Matt white		33-551-10-21
Chrom matt Matt chrome	Data bus	33-551-20-06
Weiß matt Matt white		33-551-20-21

SCHUTZLEITER RECHTS  
RIGHT PROTECTIVE EARTH



Farbe Colour	Typ Type	Artikel Item
Chrom matt Matt chrome	Standard	33-551-11-06
Weiß matt Matt white		33-551-11-21
Chrom matt Matt chrome	Data bus	33-551-21-06
Weiß matt Matt white		33-551-21-21

7.2 MITTLEEINSPEISUNG  
CENTRAL POWER SUPPLY



127 x 36 mm

Keine Kupplungsfunktion, an beliebiger Stelle ohne Teilung der Stromschiene positionierbar  
Kunststoff

No coupling function, can be positioned anywhere without dividing the track  
Plastic

STANDARD / DATA BUS

Farbe Colour	Typ Type	Artikel Item
Chrom matt Matt chrome	Standard	33-551-12-06
Weiß matt Matt white		33-551-12-21
Chrom matt Matt chrome	Data bus	33-551-22-06
Weiß matt Matt white		33-551-22-21





# READY FOR TAKE OFF

## 12 V SYSTEM

Design: Ralf Keferstein

### DAS KLEINE FEINE

READY FOR TAKE OFF ist ein graziles, einphasiges 12 Volt Schienensystem mit Esprit. Ganz gleich, ob flache oder hohe Räume, geradlinige oder gebogene Schienenverläufe und auch Kreise: READY FOR TAKE OFF passt sich Ihren Wünschen an.

Die stabile Stromschiene im Rechteckformat ist mit den Maßen 17 x 8 Millimetern diskret dimensioniert. Dank eigens konstruierter Schienenkupplungen und Träger lassen sich die Schienenelemente nahezu unsichtbar miteinander verbinden.

READY FOR TAKE OFF Leuchten werden mit unterschiedlichen Lichttechniken angeboten. Dem Anwender steht es frei, ob er sich für LED oder Halogen-Leuchten entscheidet.

Das hochwertige Schienensystem eignet sich formal hervorragend für den privaten Wohnraum und ist ebenso für eine anscheinliche Akzentbeleuchtung im gehobenen Einzelhandel und in Galerien bewährt. READY FOR TAKE OFF ist jederzeit erweiterbar und veränderbar.

Für individuell geschwungene Schienenverläufe können die Schienen werkseitig nach Wunsch gebogen werden.

### SMALL IS BEAUTIFUL

READY FOR TAKE OFF is a graceful, single-phase 12 volt track system with spirit. Whether it's flat or high spaces, straight line or curved track configurations, or even circles: READY FOR TAKE OFF adapts to your requirements.

With dimensions of 17 x 8 millimetres, the robust rectangular shaped busbar is discreetly dimensioned. Thanks to track connectors and supports designed in-house, the track elements can be connected to one another almost invisibly.

READY FOR TAKE OFF luminaires are offered with a variety of lighting technologies. The user is free to choose between LED or halogen luminaires.

The high quality track system is technically perfectly suited to private living space and is likewise tried and tested for presentable accent lighting in sophisticated retail and in galleries. READY FOR TAKE OFF can be extended and modified at any time.

For individual curved track configurations, the tracks can be curved in the factory upon request.

# ÜBERSICHT OVERVIEW

## LED

Strahler  
Spots



RIDGE  
176

A LITTLE BIT  
177



LP 111

Halogen | Retrofit

Strahler und  
Raumlichter  
Spots and  
ambient lights



LEVEL  
178



LP 111  
179



GATE B FIVE  
180



MATCH  
183



STREAM 51  
183



MX-2  
185



GATE B NINE  
185



GATE B TWO  
187



MAGIC  
187



TAIFUN  
189

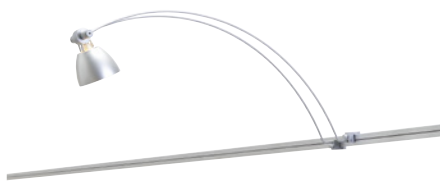

TORINO  
189

Pendelleuchten  
Pendant  
luminaires



GRACE  
190



PULL-IT  
191

PLUG-IN  
Leuchten  
(über Adapter)  
PLUG-IN  
luminaires  
(via adapter)



READY-IN  
Adapter Adapter 195  
Leuchten Luminaires 209

## READY FOR TAKE OFF INSTALLATION



A LITTLE BIT



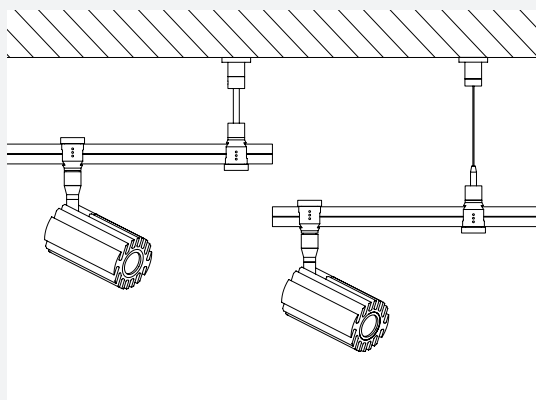

#### FLEXIBLE INSTALLATIONSMÖGLICHKEITEN

Alle READY FOR TAKE OFF Systemkomponenten lassen sich nahezu werkzeuglos kombinieren. Die Schienen können mit Trägern an der Decke montiert oder abgependelt werden. Ebenso lassen sich durch Wandträger und dazugehörige Galeriestrahler kreative Lösungen realisieren.

#### FLEXIBLE INSTALLATION OPTIONS

All READY FOR TAKE OFF system components can be combined almost without tools. The tracks can be mounted on the ceiling with supports or suspended. Creative solutions can also be realised with wall support and associated gallery spotlights.

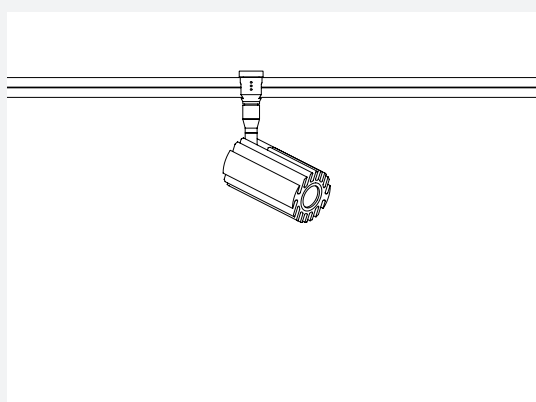

#### EINFACH UND SICHER MONTIEREN

READY FOR TAKE OFF Systemleuchten sind fest mit einem Adapter versehen. Der über die Schiene greifende Leuchtenadapter ist mit einem Federdruckmechanismus für besten Kontaktdruck ausgestattet. Er wird mit einer gerändelten Kappe mechanisch gegen Lösen gesichert.

#### INSTALL EASILY AND SAFELY

READY FOR TAKE OFF system luminaires are permanently fitted with an adapter. The luminaire adapter, which grips over the track, is equipped with a spring pressure mechanism for best contact pressure. It is mechanically secured against detaching with a ridged cap.

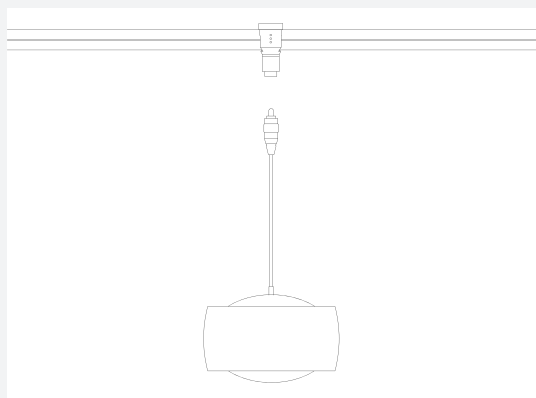

#### JEDERZEIT ERWEITERBAR

Das Schienensystem ist flexibel erweiterbar, die Leuchtauswahl zugleich nicht auf das READY FOR TAKE OFF Systemprogramm beschränkt. Über den READY-IN Adapter können sämtliche 12 Volt PLUG-IN Systemleuchten in das Schienensystem integriert werden.

#### EXPANDABLE AT ANY TIME

The track system can be flexibly expanded, and the choice of luminaires is not limited to the READY FOR TAKE OFF system range. Using the READY-IN adapter, all 12 volt PLUG-IN system luminaires can be integrated into the track system.

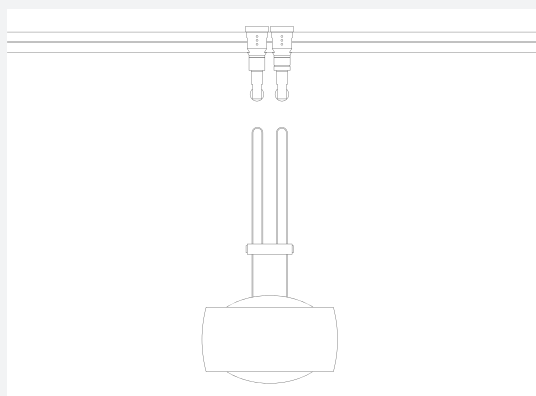

#### GROSSE LEUCHTENAUSWAHL

Auch höhenverstellbare 12 Volt Pendelleuchten lassen sich mittels PULLEY Adapter problemlos in das Schienensystem READY FOR TAKE OFF einfügen.

#### LARGE SELECTION OF LUMINAIRES

Height adjustable 12 volt pendant luminaires can also be easily integrated into the track system READY FOR TAKE OFF by using the PULLEY adapter.

# RIDGE



**Strahler**

Drehbar, schwenkbar  
Nicht dimmbar

Aluminium

**Spotlight**

Rotatable, tiltable  
Not dimmable

Aluminium

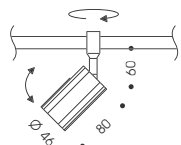

12 V 0,2 kg

LED | 550 lm | 10,3 W AC | 7,6 W DC | 52° | CRI >90

Leuchte Luminaire	2700 K	3000 K
<b>Chrom matt</b> Matt chrome	11-889-21-06	11-889-31-06

Magnetischer 12 V Transformator oder 12 V Gleichspannungsnetzteil erforderlich  
Magnetic 12 V transformer or 12 V DC power supply required



FOKUSSIERBAR

READY FOR TAKE OFF

# A LITTLE BIT

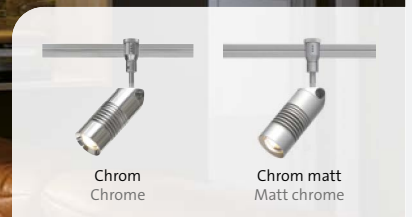

### Strahler

Drehbar, schwenkbar  
Nicht dimmbar

Aluminium, Glaslinse

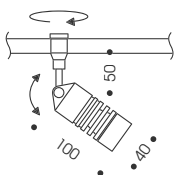

12 V 0,3 kg

### Spotlight

Rotatable, tiltable  
Not dimmable

Aluminium, glass lens

LED | 550 lm | 10,3 W AC | 7,6 W DC | 20 - 60° | CRI >90

Leuchte Luminaire	2700 K	3000 K
Chrom Chrome	11-898-40-05	11-898-50-05
Chrom matt Matt chrome	11-898-40-06	11-898-50-06

Magnetischer 12 V Transformator oder 12 V Gleichspannungsnetzteil erforderlich  
Magnetic 12 V transformer or 12 V DC power supply required

12 V SYSTEM



EXTERN  
DIMMBAR



FÜR RETROFIT  
GEEIGNET

# LEVEL

Design: Ralf Keferstein



Strahler

Leuchtmittel kardanisch gelagert

Montage: Der Mindestabstand zur Decke muss 150 mm betragen

Metall

Spotlight

Gimbal-mounted lamp

Mounting: The minimum distance to the ceiling must be 150 mm

Metal

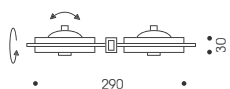

12 V 0,3 kg

G 53 | QR-LP 111 Halogen max. 2x 50 W | Retrofit

Leuchte Luminaire

Artikel Item

Chrom matt  
Matt chrome

11-905-20-06



EXTERN  
DIMMBAR



FÜR RETROFIT  
GEEIGNET

READY FOR TAKE OFF

# LP 111

Design: Ralf Keferstein



Strahler

Drehbar, schwenkbar

Metall

Spotlight

Rotatable, tiltable

Metal

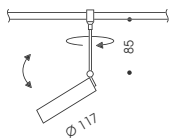

12 V 0,3 kg

G 53 | QR-LP 111 Halogen max. 50 W | Retrofit

Leuchte Luminaire

Artikel Item

Chrom matt  
Matt chrome

11-934-10-06

# GATE B FIVE

Design: Ralf Keferstein



Chrom matt | 40 mm  
Matt chrome | 40 mm



Chrom matt | 140 mm  
Matt chrome | 140 mm

GATE B FIVE



EXTERN  
DIMMBAR



FÜR RETROFIT  
GEEIGNET

READY FOR TAKE OFF



GATE B FIVE | GATE B TUBE

Strahler

Drehbar, schwenkbar

Metall

Spotlight

Rotatable, tiltable

Metal

GATE B FIVE | 40 mm

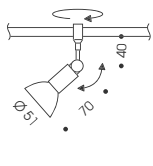

12 V 0,1 kg

GATE B FIVE | 140 mm

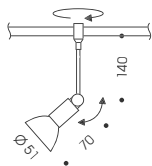

12 V 0,1 kg

GU 5,3 | QR-CBC 51 Halogen max. 50 W | Retrofit

Leuchte Luminaire	Länge Length	Artikel Item
Chrom Chrome	40 mm	11-974-10-05
Chrom matt Matt chrome		11-974-10-06
Chrom Chrome	140 mm	11-974-11-05
Chrom matt Matt chrome		11-974-11-06

Leuchtmittelzubehör GATE B TUBE siehe unten. Weiteres Zubehör ab Seite 244  
GATE B TUBE accessory see below. Further accessories from page 244

GATE B TUBE

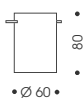

0,1 kg

OPTION: GATE B TUBE

Typ Type	Farbe Colour	Artikel Item
Glasschirm Glass shade	Teilsatiniert Partial satin finish	62-111-11-01



STREAM 51





EXTERN  
DIMMBAR



FÜR RETROFIT  
GEEIGNET

READY FOR TAKE OFF

## MATCH



Chrom | Ring R2  
Chrome | R2 ring

Chrom matt  
Matt chrome

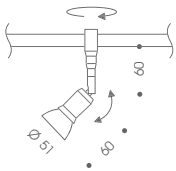

12 V 0,2 kg

Strahler

Drehbar, schwenkbar

Metall

Spotlight

Rotatable, tiltable

Metal

GU 5,3 | QR-CBC 51 Halogen max. 50 W | Retrofit

Leuchte Luminaire	Artikel Item
Chrom Chrome	11-892-10-05
Chrom matt Matt chrome	11-892-10-06

Leuchtmittelzubehör ab Seite 244  
Lamp accessories from page 244

## STREAM 51

Design: Ralf Keferstein



Chrom  
Chrome

Chrom matt  
Matt chrome

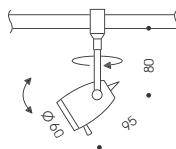

12 V 0,3 kg

Strahler

Drehbar, schwenkbar

Halogen: "Cool beam" nicht zulässig  
Retrofit: Gesamtlänge ≤48 mm empfohlen

Metall

Spotlight

Rotatable, tiltable

Halogen: "Cool beam" not permitted

Retrofit: total length ≤48 mm recommended

Metal

GU 5,3 | QR-C 51 Halogen max. 50 W | Retrofit

Leuchte Luminaire	Artikel Item
Chrom Chrome	11-945-10-05
Chrom matt Matt chrome	11-945-10-06



GATE B NINE



EXTERN  
DIMMBAR



FÜR RETROFIT  
GEEIGNET

READY FOR TAKE OFF

## MX-2

Design: Ralf Keferstein



Chrom matt, 250 mm  
Matt chrome, 250 mm

Schirm S1  
S1 shade

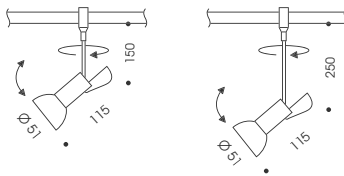

12 V 0,2 kg

12 V 0,2 kg

Strahler

Drehbar, schwenkbar

Metall

Spotlight

Rotatable, tiltable

Metal

GU 5,3 | QR-CBC 51 Halogen max. 50 W | Retrofit

Leuchte Luminaire	Adapter Adapter	Länge Length	Artikel Item
Chrom matt Matt chrome	Chrom Chrome	150 mm	11-959-10-06
Chrom matt Matt chrome	Chrom matt Matt chrome	150 mm	11-959-20-06
Chrom matt Matt chrome	Chrom matt Matt chrome	250 mm	11-959-30-06

Leuchtmittelzubehör ab Seite 244  
Lamp accessories from page 244

## GATE B NINE

Design: Ralf Keferstein



Chrom  
Chrome

Chrom matt  
Matt chrome

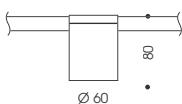

12 V 0,2 kg

Strahler

Halogen: "Cool beam" nicht zulässig

Metall

Spotlight

Halogen: "Cool beam" not permitted

Metal

GU 5,3 | QR-C 51 Halogen max. 35 W | Retrofit

Leuchte Luminaire	Artikel Item
Chrom Chrome	11-901-10-05
Chrom matt Matt chrome	11-901-10-06



GATE B FIVE



EXTERN  
DIMMBAR



FÜR RETROFIT  
GEEIGNET

READY FOR TAKE OFF

## GATE B TWO

Design: Ralf Keferstein



Wei matt  
Matt white

Ananas  
Pineapple

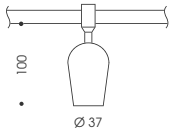

12 V 0,1 kg

Raumlicht  
Metall, Glas

Ambient light  
Metal, glass

G 4 | QT-LP 9 Halogen max. 20 W | Retrofit

Schirm Shade	Adapter Adapter	Artikel Item
Wei matt Matt white	Chrom matt Matt chrome	11-972-10-06/21
Ananas Pineapple	Chrom matt Matt chrome	11-972-10-06/32

## MAGIC

Design: Ralf Keferstein



Wei matt | Chrom matt  
Matt white | Matt chrome

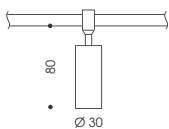

12 V 0,1 kg

Raumlicht  
Metall, Borosilikatglas

Ambient light  
Metal, borosilicate glass

G 4 | QT-LP 9 Halogen max. 20 W | Retrofit

Schirm Shade	Adapter Adapter	Artikel Item
Wei White	Chrom Chrome	11-961-10-05/21
Wei White	Chrom matt Matt chrome	11-961-10-06/21



TORINO



EXTERN  
DIMMBAR



FÜR RETROFIT  
GEEIGNET

READY FOR TAKE OFF

# TAIFUN

Design: Ralf Keferstein



Chrom matt | 400 mm  
Matt chrome | 400 mm



Schirm S1  
S1 shade

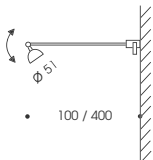

12 V 0,1 kg

Galeriestrahler

Kopf schwenkbar  
Version 400 mm kürzbar bis 100 mm

Metall

Gallery spotlight

Head swivelling  
400 mm version can be shortened up to 100 mm minimum length

Metal

GU 5,3 | QR-CBC 51 Halogen max. 50 W | Retrofit

Leuchte Luminaire	Länge Length	Artikel Item
Chrom matt Matt chrome	100 mm	11-944-10-06
Chrom Chrome	400 mm	11-944-11-05
Chrom matt Matt chrome		11-944-11-06

Leuchtmittelzubehör ab Seite 244  
Lamp accessories from page 244

# TORINO

Design: Ralf Keferstein



Chrom matt  
Matt chrome



Ring R2  
R2 ring

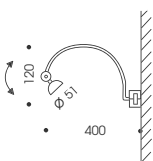

12 V 0,1 kg

Galeriestrahler

Kopf schwenkbar

Metall

Gallery spotlight

Head swivelling

Metal

GU 5,3 | QR-CBC 51 Halogen max. 50 W | Retrofit

Farbe Adapter Adapter colour	Artikel Item
Chrom Chrome	11-943-10-05
Chrom matt Matt chrome	11-943-10-06

Leuchtmittelzubehör ab Seite 244  
Lamp accessories from page 244

EXTERN  
DIMMBARFÜR RETROFIT  
GEEIGNET

## GRACE

Design: Ralf Keferstein

Chrom  
ChromeAluminium gebürstet  
Brushed aluminium

## Pendelleuchte

Höhenverstellbar, kürzbar  
Abhängung auf Anfrage bis 5 m erhältlich

Metall, Glas

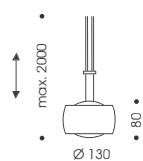

12 V 0,7 kg

## Pendant luminaire

Height adjustable, can be shortened  
Suspension available up to 5 m on request

Metal, glass

GY 6,35 | QT-LP 12 Halogen max. 50 W | Retrofit

Leuchte Luminaire

Artikel Item

Chrom  
Chrome

10-931-10-05

Aluminium gebürstet  
Brushed aluminium

10-931-10-12

Adapter separat bestellen auf Seite 195  
Order adapter separately on page 195





EXTERN  
DIMMBAR



FÜR RETROFIT  
GEEIGNET

READY FOR TAKE OFF

# PULL-IT

Design: Ralf Keferstein



Transparent  
Transparent

Weiß matt  
Matt white



reddot

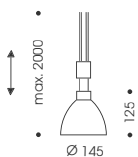

12 V 1,4 kg

Pendelleuchte

Höhenverstellbar, kürzbar  
Abhängung auf Anfrage bis 5 m  
erhältlich

Metall, Glas mundgeblasen

Pendant luminaire

Height adjustable, can be shortened  
Suspension available up to 5 m on  
request

Metal, hand-blown glass

GY 6,35 | QT-LP 12 Halogen max. 50 W | Retrofit

Leuchte Luminaire

Artikel Item

Transparent  
Transparent

10-952-10-06/01

Weiß matt  
Matt white

10-952-10-06/21

Adapter separat bestellen auf Seite 195  
Order adapter separately on page 195

# SEVEN MILES FINAL

Design: Ralf Keferstein



SEVEN MILES FINAL | A LITTLE BIT



SEVEN MILES FINAL | GATE B FIVE

**HALOGEN TRANSFORMATOR**  
HALOGEN TRANSFORMER



Inklusive Schienenendkappen  
Elektronischer Transformator  
Sekundärseitig zulässige Leitungslänge <2m  
Kompatibel mit Dimmer "Typ C"  
Schutzklasse 1  
Metall, Kunststoff

Track end caps included  
Electronic transformer  
Secondary permissible cable length <2m  
Compatible with "Type C" dimmer  
Protection class 1  
Metal, Plastic

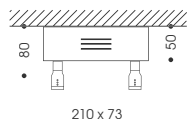

230 V | 50-60 HZ | 12 V | 50-150 VA

Farbe	Colour	Artikel Item
Chrom	Chrome	60-435-10-05
Chrom matt	Matt chrome	60-435-10-06

**LED SCHALTNETZTEIL 12 V DC**  
LED SWITCH-MODE POWER SUPPLY 12 V DC



Inklusive Schienenendkappen  
Schutzklasse 1  
Metall, Kunststoff

Track end caps included  
Protection class 1  
Metal, Plastic

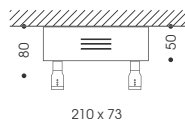

230 V | 50-60 HZ | 12 V DC | 0-30 VA

Farbe	Colour	Artikel Item
Chrom	Chrome	60-442-10-05
Chrom matt	Matt chrome	60-442-10-06

**SCHIENE**  
TRACK



17 x 8 x 1000 / 1500 mm

Metall  
Metal

Farbe Colour	Länge Length	Artikel Item
Chrom Chrome	1000 mm	12-201-10-05
Chrom matt Matt chrome		12-201-10-06
Chrom Chrome	1500 mm	12-201-11-05
Chrom matt Matt chrome		12-201-11-06



READY-IN | BALINO

# PULLEY

Design: Ralf Keferstein



Chrom matt  
Matt chrome

Kompatibel mit Compatible with



GRACE  
190



PULL-IT  
191

Systemadapter für 12 V Pendelleuchten mit Höhenverstellung

Das Eigengewicht der Leuchten kann die Installation von zusätzlichen Schienenträgern erfordern.

Metall

System adapter for 12 V pendant luminaires with height adjustment

The self-weight of the luminaires may require the installation of additional track supports.

Metal

12 V | max. 5 A

Farbe Adapter Adapter colour	Artikel Item
Chrom Chrome	12-644-10-05
Chrom matt Matt chrome	12-644-10-06

Leuchten separat bestellen  
Order luminaires separately

# READY-IN

Design: Ralf Keferstein



Chrom matt  
Matt chrome

Kompatibel mit (Beispiele) Compatible with (Examples)



BENE DICT  
220



CHARLES  
221



BALINO  
225

Systemadapter für 12 V PLUG-IN Steckkontaktleuchten

Das Eigengewicht der Leuchten kann die Installation von zusätzlichen Schienenträgern erfordern.

Metall

System adapter for 12 V PLUG-IN plug contact luminaires

The self-weight of the luminaires may require the installation of additional track supports.

Metal

12 V | max. 5 A

Farbe Adapter Adapter colour	Artikel Item
Chrom Chrome	12-621-10-05
Chrom matt Matt chrome	12-621-10-06

PLUG-IN Leuchten separat bestellen ab Seite 209  
Order PLUG-IN luminaires separately from page 209

# SYSTEMKOMPONENTEN

## SYSTEM COMPONENTS

Design: Ralf Keferstein

12 V | max. 25 A

Die Komponenten eines Schienensystems variieren je nach Anwendungssituation und individuellen Anforderungen des Kunden. Ein funktionsfähiges System besteht immer aus bestimmten Basiskomponenten.

Die nachfolgende Checkliste erleichtert die Prüfung zur Vollständigkeit des Systems und dient als Leitfaden für die richtige Auswahl der Komponenten.

Beispiele Examples

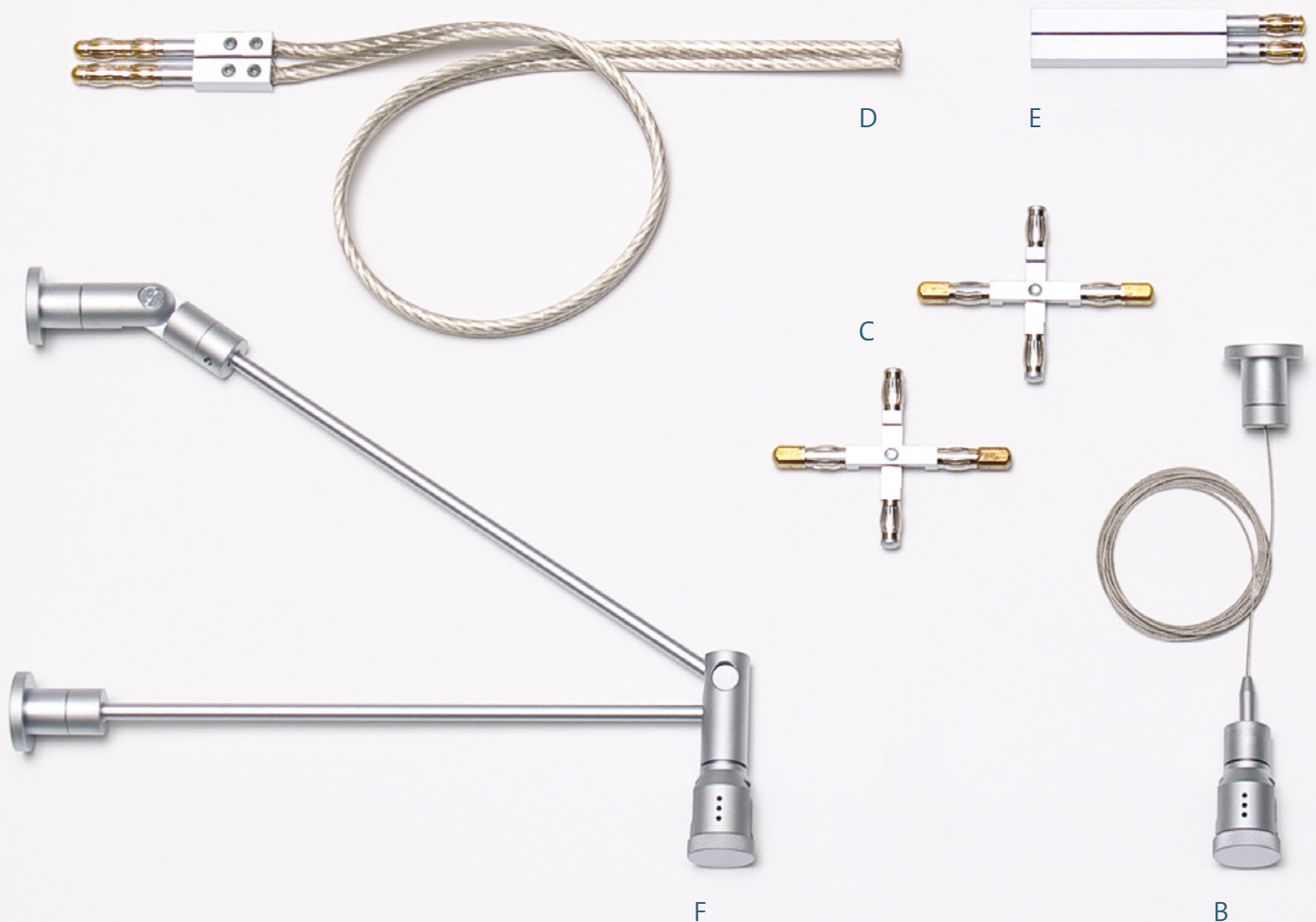

The components in a track system vary according to the situation in which it is used and the customer's individual requirements. A functional system always consists of certain base components.

The following checklist facilitates checking the completeness of the system and serves as a guideline for choosing the right components.



**CHECKLISTE BASISKOMPONENTEN**  
CHECKLIST BASIC COMPONENTS

- A **Stromschiene**  
Track
- B **Träger | Abhängung**  
Support | Suspension
- C **Kupplung**  
Connector
- D **Einspeisung**  
Power supply
- E **Endstücke | Endkappen**  
End piece | End cap  
Transformator od. Netzteil, systemseitig oder extern  
Power supply, in the system or external

**SPEZIFISCHE KOMPONENTEN**  
SPECIFIC COMPONENTS

- F **Schienausleger**  
Track arm  
**Bildaufhängung**  
Picture mounting

## SYSTEMPLANUNG

Bei der Planung des Schienensystems müssen bestimmte Vorgaben zu Distanzen und Gewichten beachtet werden.

## SYSTEM PLANNING

When planning the track system, certain specifications regarding distances and weights must be ensured.

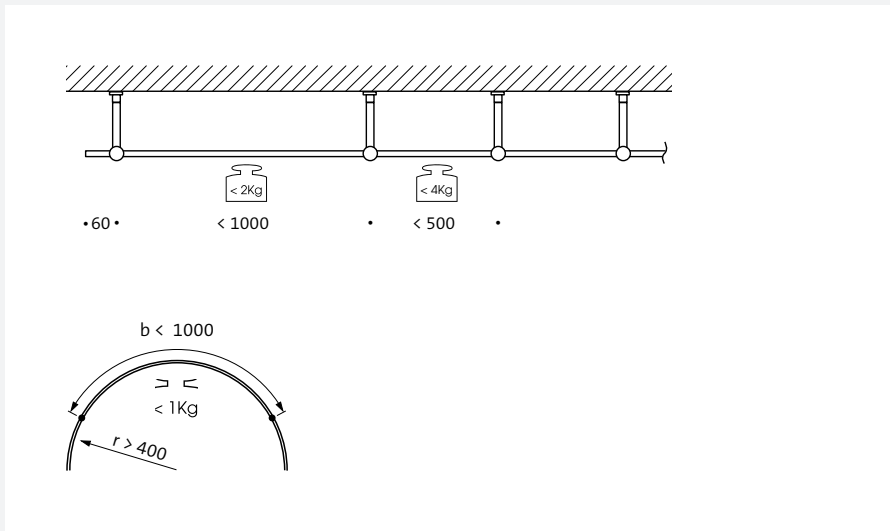

### 1.1 SCHIENE, GERADE STRAIGHT TRACK



17 x 8 mm / 28 mm<sup>2</sup>

Kürzbar  
Metall

Can be shortened  
Metal

### 1.2 SCHIENE, GEBOGEN CURVED TRACK



17 x 8 mm / 28 mm  
 $r = \dots (\gt 400mm)$

Kürzbar  
Zur Bildung von Vollkreisen Kupplung 3.1  
bzw. 3.2 bestellen  
Metall

Can be shortened  
To form full circles, order connector 3.1 or 3.2  
Metal

### 2.1 TRÄGER Ø 14 mm SUPPORT Ø 14 mm



Metall  
Metal

Farbe Colour	Länge Length	Artikel Item
Chrom Chrome	1000 mm	12-201-10-05
Chrom matt Matt chrome		12-201-10-06
Chrom Chrome	1500 mm	12-201-11-05
Chrom matt Matt chrome		12-201-11-06

Farbe Colour	Länge Length	Artikel Item
Chrom Chrome	840 mm	12-211-10-05
Chrom matt Matt chrome		12-211-10-06
Chrom Chrome	1340 mm	12-211-11-05
Chrom matt Matt chrome		12-211-11-06

Farbe Colour	Länge Length	Artikel Item
Chrom Chrome	20 mm	12-301-10-05
Chrom matt Matt chrome		12-301-10-06
Chrom Chrome	30 mm	12-301-11-05
Chrom matt Matt chrome		12-301-11-06



2.2 TRÄGER ABDECKSCHEIBE  
SUPPORT COVER DISC



Ø 24 x 4 mm

Optionales Zubehör  
Kompatibel: 2.1  
Metall

Optional accessory  
Compatible: 2.1  
Metal

Farbe Colour	Artikel Item
Chrom Chrome	12-311-10-05
Chrom matt Matt chrome	12-311-10-06

2.3 TRÄGER Ø 5 mm  
SUPPORT Ø 5 mm



Kürzbar  
Metall

Can be shortened  
Metal

Farbe Colour	Länge Length	Artikel Item
Chrom Chrome	80 mm	12-301-12-05
Chrom matt Matt chrome		12-301-12-06
Chrom Chrome	100 mm	12-301-13-05
Chrom matt Matt chrome		12-301-13-06
Chrom Chrome	225 mm	12-301-14-05
Chrom matt Matt chrome		12-301-14-06
Chrom Chrome	525 mm	12-301-15-05
Chrom matt Matt chrome		12-301-15-06
Chrom matt Matt chrome	1025 mm	12-301-16-06

2.4 TRÄGER ZUSATZGELENK  
SUPPORT ADDITIONAL JOINT



Schwenkbereich 90 - 180°  
Kompatibel: 2.1 / 2.3  
Metall

Swivel range 90 - 180°  
Compatible: 2.1 / 2.3  
Metal

Farbe Colour	Artikel Item
Chrom Chrome	62-303-01-05
Chrom matt Matt chrome	62-303-01-06

2.5 ABHÄNGUNG  
SUSPENSION



1500 mm

Kürzbar  
Metall

Can be shortened  
Metal

Farbe Colour	Artikel Item
Chrom Chrome	12-331-10-05
Chrom matt Matt chrome	12-331-10-06

2.6 TRÄGER, WAND  
SUPPORT, WALL



30 x 21 x 24 mm

Metall  
Metal

Farbe Colour	Artikel Item
Chrom Chrome	12-321-10-05
Chrom matt Matt chrome	12-321-10-06

**2.7 SCHIENENAUSLEGER  
TRACK ARM**



Wandabstand 200 mm  
Kürzbar  
Metall

Wall distance 200 mm  
Can be shortened  
Metal

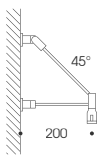

**3.1 I-KUPPLUNG  
I-CONNECTOR**



Für gerade und gebogene Schiene  
Kompatibel: 1.1 / 1.2 (R > 1000 mm)  
Metall

For straight and curved track  
Compatible: 1.1 / 1.2 (R > 1000 mm)  
Metal

LEITEND CONDUCTIVE

**3.2 I-KUPPLUNG  
I-CONNECTOR**



Für gebogene Schiene  
Kompatibel: 1.2 (R < 1000 mm)  
Metall

For curved track  
Compatible: 1.2 (R < 1000 mm)  
Metal

LEITEND CONDUCTIVE

Farbe Colour	Artikel Item
Chrom Chrome	12-351-10-05
Chrom matt Matt chrome	12-351-10-06

Farbe Colour	Artikel Item
Chrom Chrome	12-401-10-05

Farbe Colour	Artikel Item
Chrom Chrome	12-403-10-05

**3.3 I-KUPPLUNG  
I-CONNECTOR**



Für gerade und gebogene Schiene  
Kompatibel: 1.1 / 1.2  
Kunststoff

For straight and curved track  
Compatible: 1.1 / 1.2  
Plastic

ISOLIEREND INSULATING

Farbe Colour	Artikel Item
Grau matt Matt grey	12-401-11-05

**3.4 SCHWENKKUPPLUNG, HORIZONTAL  
SWIVEL CONNECTOR, HORIZONTAL**



Schwenkbereich 60 - 180°  
Metall

Swivel range 60 - 180°  
Metal

LEITEND CONDUCTIVE

**3.5 SCHWENKKUPPLUNG, VERTIKAL  
SWIVEL CONNECTOR, VERTICAL**



Schwenkbereich 60 - 180°  
Metall

Swivel range 60 - 180°  
Metal

LEITEND CONDUCTIVE

Farbe Colour	Artikel Item
Chrom Chrome	12-411-10-05
Chrom matt Matt chrome	12-411-10-06

Farbe Colour	Artikel Item
Chrom Chrome	12-411-11-05
Chrom matt Matt chrome	12-411-11-06

**3.6 T-KUPPLUNG**  
T-CONNECTOR



Schwenkbereich 60 - 90°  
Metall

Swivel range 60 - 90°  
Metal

LEITEND CONDUCTIVE

Farbe Colour	Artikel Item
Chrom Chrome	12-421-10-05
Chrom matt Matt chrome	12-421-10-06

**3.7 X-KUPPLUNG**  
X-CONNECTOR



Schwenkbereich 60 - 90°  
Metall

Swivel range 60 - 90°  
Metal

LEITEND CONDUCTIVE

Farbe Colour	Artikel Item
Chrom matt Matt chrome	12-431-10-06

**3.8 FLEKKUPPLUNG**  
FLEXIBLE CONNECTOR



6 mm<sup>2</sup> / 50 mm

Metall  
Metal

LEITEND CONDUCTIVE

Farbe Colour	Artikel Item
Chrom Chrome	12-461-10-05
Chrom matt Matt chrome	12-461-10-06

**4.1 ENDSTÜCK**  
END PIECE



17 x 8 x 60 mm

Metall  
Metal

Farbe Colour	Artikel Item
Chrom Chrome	12-601-10-05
Chrom matt Matt chrome	12-601-10-06

**4.2 ENDKAPPEN**  
END CAP



8 x 8 x 12 mm

Kunststoff  
Plastic

Farbe Colour	Artikel Item
Schwarz matt Matt black	12-601-11-23

**5. BILDAUFHÄNGUNG**  
PICTURE MOUNTING



1 Paar  
Metall, Kunststoff

1 pair  
Metal, plastic

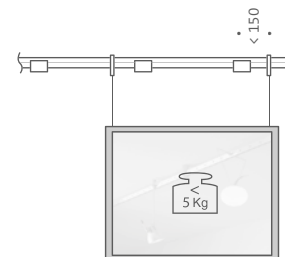

Farbe Colour	Länge Length	Artikel Item
Schwarz matt Matt black	1500 mm	62-301-02-23

**6.1 EINSPEISUNG, STANGE**  
POWER SUPPLY, ROD



Kürzbar  
Kompatibel: 7.1 / 7.2 / 8 / 9  
Metall

Can be shortened  
Compatible: 7.1 / 7.2 / 8 / 9  
Metal

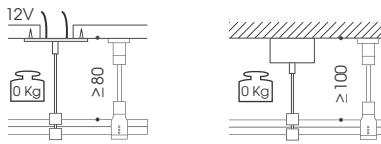

Farbe Colour	Länge Length	Artikel Item
Chrom Chrome	250 mm	12-513-10-05
Chrom matt Matt chrome		12-513-10-06

**6.2 EINSPEISUNG, EINBAU**  
POWER SUPPLY, RECESSED



Kürzbar  
Kompatibel: 2.3  
Rückseitige Arretierung  
Metall

Can be shortened  
Compatible: 2.3  
Rear lock  
Metal

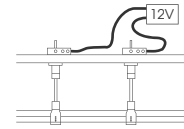

Farbe Colour	Länge Length	Artikel Item
Chrom matt Matt chrome	250 mm	12-513-20-06
Chrom matt Matt chrome	550 mm	12-513-21-06

**6.3 ENDEINSPEISUNG**  
END POWER SUPPLY



8 x 17 x 25 mm / 6 mm<sup>2</sup>

Stecker  
Kompatibel: 7.3 / 10  
Metall

Plug  
Compatible: 7.3 / 10  
Metal

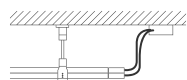

Farbe Colour	Artikel Item
Chrom Chrome	12-511-10-05
Chrom matt Matt chrome	12-511-10-06

**6.4 ENDEINSPEISUNG**  
END POWER SUPPLY



8 x 17 x 25 mm / 6 mm<sup>2</sup> / 500 mm

Stecker + Kabel, kürzbar  
Kompatibel: 8 / 9  
Metall

Plug + Cable, can be shortened  
Compatible: 8 / 9  
Metal

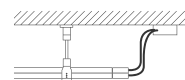

Farbe Colour	Artikel Item
Chrom Chrome	12-511-11-05
Chrom matt Matt chrome	12-511-11-06

**6.5 MITTELSPEISUNG, SEITLICH**  
CENTRAL POWER SUPPLY, LATERAL



Ø 10 x 30 mm / 6 mm<sup>2</sup>

Kompatibel: 7.3 / 10  
Metall

Compatible: 7.3 / 10  
Metal

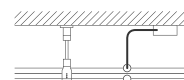

**KLEMMEN CLAMPS**

Farbe Colour	Artikel Item
Chrom Chrome	12-511-20-05
Chrom matt Matt chrome	12-511-20-06

**6.6 MITTELEINSPEISUNG, SEITLICH**  
CENTRAL POWER SUPPLY, LATERAL



Ø 10 x 30 mm / 6 mm<sup>2</sup> / 500 mm

Kürzbar  
Kompatibel: 8 / 9  
Metall

Can be shortened  
Compatible: 8 / 9  
Metal

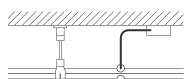

**KLEMMEN + KABEL** CLAMPS + CABLE

Farbe Colour	Artikel Item
Chrom Chrome	12-511-21-05
Chrom matt Matt chrome	12-511-21-06

**6.7 MITTELEINSPEISUNG, SENKRECHT**  
CENTRAL POWER SUPPLY, VERTICAL



Ø 10 x 25 mm / 6 mm<sup>2</sup>

Kompatibel: 7.3 / 10  
Metall

Compatible: 7.3 / 10  
Metal

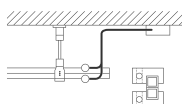

**KLEMMEN** CLAMPS

Farbe Colour	Artikel Item
Chrom Chrome	12-511-30-05
Chrom matt Matt chrome	12-511-30-06

**6.8 MITTELEINSPEISUNG, SENKRECHT**  
CENTRAL POWER SUPPLY, VERTICAL



Ø 10 x 25 mm / 6 mm<sup>2</sup> / 500 mm

Kürzbar  
Kompatibel: 8 / 9  
Metall

Can be shortened  
Compatible: 8 / 9  
Metal

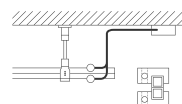

**KLEMMEN + KABEL** CLAMPS + CABLE

Farbe Colour	Artikel Item
Chrom Chrome	12-511-31-05
Chrom matt Matt chrome	12-511-31-06

**7.1 EINSPEISUNG, DECKENEINBAU**  
POWER SUPPLY, RECESSED CEILING



Ø 95 x 5 mm / 51 mm

Kompatibel: 2.3 (≥ 80 mm)  
Metall

Separat bestellen: 6.1

Compatible: 2.3 (≥ 80 mm)  
Metal

Order separately: 6.1

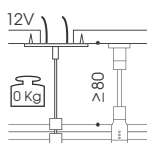

Farbe Colour	Artikel Item
Chrom Chrome	12-501-10-05
Chrom matt Matt chrome	12-501-10-06

**7.2 EINSPEISUNG, DECKENAUFBAU**  
POWER SUPPLY, CEILING MOUNTED



Ø 82 x 24 mm / 70 mm

Kompatibel: 2.3 (≥ 80 mm)  
Metall

Separat bestellen: 6.1

Compatible: 2.3 (≥ 80 mm)  
Metal

Order separately: 6.1

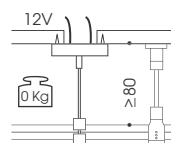

Farbe Colour	Artikel Item
Chrom Chrome	12-501-11-05
Chrom matt Matt chrome	12-501-11-06

**7.3 EINSPEISUNG, AUFBAU**  
POWER SUPPLY, SURFACE MOUNTED



Ø 82 x 24 mm / 4 mm<sup>2</sup> / 500 mm

Kürzbar  
Kompatibel: 2.3 (≥ 80 mm)  
Metall

Separat bestellen: 6.3 / 6.5 / 6.7

Can be shortened  
Compatible: 2.3 (≥ 80 mm)  
Metal

Order separately: 6.3 / 6.5 / 6.7

**KABEL SEITLICH** LATERAL CABLE

Farbe Colour	Artikel Item
Chrom Chrome	12-501-12-05
Chrom matt Matt chrome	12-501-12-06



GATE B FIVE

# TRANSFORMATOREN UND GLEICHSPANNUNGSNETZTEILE

## TRANSFORMERS AND DC POWER SUPPLY UNITS

Kombinationsmöglichkeiten von LED Leuchten und verschiedener Leuchtmitteltypen mit Transformatoren und Gleichspannungsnetzteilen

Options for combination of LED luminaires and various lamp types with transformers and DC power supply units

Magnetischer Transformator Magnetic transformer	VA	Katalogseite Page	LED Leuchten LED luminaires	Retrofit Leuchtmittel Retrofit lamps	Halogen Leuchtmittel Halogen lamps
CHARGE	105 / 200 / 300	206	•	•	•
extern, z.B. MT 1 external, i.e. MT 1	105 / ... / 400	241	•	•	•
Zulässige LED Leuchten- bzw. Leuchtmittelkombinationen siehe Tabelle unten. Permissible LED luminaire or lamp combinations see table below.					
Elektronischer Transformator Electronic transformer					
TRANSFORMER 150	150	207			•
TRANSFORMER 150 - TO	150	207			•
SEVEN MILES FINAL	150	192			•
extern, z.B. ET 5 external, i.e. ET 5	105	241			•
Gleichspannungsnetzteil 12 V DC 12 V DC power supply unit					
SEVEN MILES FINAL 12 V DC	30	192	•	•	
extern, z.B. DC 1 external, i.e. DC 1	45 / 60	241	•	•	
Der Betrieb von LED-Leuchten und 12 V DC tauglichen Retrofit-Leuchtmitteln innerhalb des selben Systems ist zulässig. The operation of LED luminaires and 12 V DC compatible retrofit lamps within the same system is permissible					

Zulässige LED Leuchten- bzw. Leuchtmittelkombinationen innerhalb eines READY FOR TAKE OFF Schienensystems mit magnetischem Transformator

Permissible LED luminaire and lamp combinations within a READY FOR TAKE OFF track system with magnetic transformer

	LED Leuchten LED luminaires	Retrofit Leuchtmittel Retrofit lamps	Halogen Leuchtmittel Halogen lamps
LED Leuchten LED luminaires	•		•
Retrofit Leuchtmittel Retrofit lamps		•	•
Halogen Leuchtmittel Halogen lamps	•	•	•

Um die Lebensdauer von Halogen-Leuchtmitteln bei gleichzeitigem Betrieb von LED-Leuchten und / oder Retrofit-Leuchtmitteln nicht negativ zu beeinflussen, sollte eine Auslastung von mindestens 70 % der angegebenen, maximalen Leistung des Transformators gewährleistet sein.

In order to avoid negatively affecting the service life of halogen lamps during simultaneous operation of LED luminaires and / or retrofit lamps, a load of at least 70 % of the specified maximum capacity of the transformer should be ensured.

# TRANSFORMATOREN

230 V | 50-60 Hz | 12 V

Schutzklasse 1

Externe Transformatoren und externe 12 V Gleichspannungsnetzteile ab Seite 240

# TRANSFORMER

230 V | 50-60 Hz | 12 V

Protection class 1

External transformers and external 12 V DC power supply units from page 240

## 8. CHARGE-1



105 VA / Ø 120 x 57 / 76 mm  
 200 VA / Ø 140 x 72 / 93 mm  
 300 VA / Ø 140 x 72 / 93 mm

Magnetischer Transformator SELV, dimmbar mit Dimmer Typ L  
 Version 300 VA inklusive Stromdrossel  
 Kompatibel: 2.3 (≥ 100 mm)  
 Metall

Separat bestellen: Einspeisung 6.1 / 6.4 / 6.6 / 6.8

Magnetic transformer SELV, dimmable with dimmer type L  
 Version 300 VA including power inductor  
 Compatible: 2.3 (≥ 100 mm)  
 Metal

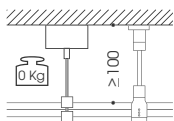

Order separately: Power supply 6.1 / 6.4 / 6.6 / 6.8

Farbe Colour	105 VA	200 VA	300 VA
<b>Chrom</b> Chrome		60-126-11-05	60-126-12-05
<b>Chrom matt</b> Matt chrome	60-126-10-06	60-126-11-06	60-126-12-06

## 9. CHARGE-2



105 VA / Ø 116 x 53 / 73 mm  
 200 VA / Ø 127 x 67 / 86 mm  
 300 VA / Ø 140 x 66 / 85 mm

Magnetischer Transformator SELV, dimmbar mit Dimmer Typ L  
 Version 300 VA inklusive Stromdrossel  
 Kompatibel: 2.3 (≥ 100 mm)  
 Metall

Separat bestellen: Einspeisung 6.1 / 6.4 / 6.6 / 6.8

Magnetic transformer SELV, dimmable with dimmer type L  
 Version 300 VA including power inductor  
 Compatible: 2.3 (≥ 100 mm)  
 Metal

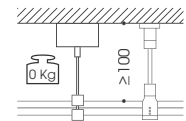

Order separately: Power supply 6.1 / 6.4 / 6.6 / 6.8

Farbe Colour	105 VA	200 VA	300 VA
<b>Weiß matt</b> Matt white	60-127-10-21	60-127-11-21	60-127-12-21



10. TRANSFORMER 150



210 x 75 x 54 mm

Inklusive 100/300 mm Kabel 2,5 mm<sup>2</sup>  
 Elektronischer Transformator  
 Sekundärseitig zulässige Leitungslänge <2 m  
 Kompatibel mit Dimmer Typ C, kapazitiv  
 Kompatibel: 2.1 (30 mm)  
 Metall

Separat bestellen: Einspeisung 6.3 / 6.5 / 6.7

100/300 mm cable 2,5 mm<sup>2</sup> included  
 Electronic transformer  
 Permissible cable length on secondary side <2 m  
 Compatible with dimmer type C, capacitive  
 Compatible: 2.1 (30 mm)  
 Metal

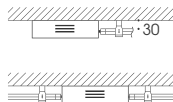

Order separately: Power supply 6.3 / 6.5 / 6.7

Farbe Colour	35 - 150 VA
Chrom Chrome	60-132-10-05
Chrom matt Matt chrome	60-132-10-06

11. TRANSFORMER 150 - TO



210 x 75 x 54 / 90 mm

Elektronischer Transformator  
 Sekundärseitig zulässige Leitungslänge <2 m  
 Kompatibel mit Dimmer Typ C, kapazitiv  
 Kompatibel: 2.3 (80 mm)  
 Metall

Electronic transformer  
 Permissible cable length on secondary side <2 m  
 Compatible with dimmer type C, capacitive  
 Compatible: 2.3 (80 mm)  
 Metal

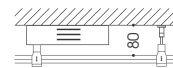

Farbe Colour	50 - 150 VA
Chrom Chrome	60-133-10-05
Chrom matt Matt chrome	60-133-10-06

## GLEICHSPANNUNGSNETZTEILE

230 V | 50-60 Hz | 12 V DC

Schutzklasse 1  
 Externe 12 V Gleichspannungsnetzteile ab Seite 240

## DC POWER SUPPLY UNITS

230 V | 50-60 Hz | 12 V DC

Protection class 1  
 External 12 V DC power supply units from page 240

12. CONNECT



Ø 60 x 328 / 100 mm

Schaltnetzteil 12 V DC  
 Kompatibel: 2.3 (100 mm)  
 Kompatibel mit LED-Leuchten  
 Metall

Switching power supply 12 V DC  
 Compatible: 2.3 (100 mm)  
 Compatible with LED luminaires  
 Metal

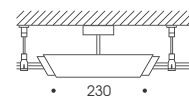
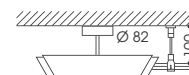

Farbe Colour	60 VA
Chrom Chrome	60-141-10-05
Chrom matt Matt chrome	60-141-10-06





# PLUG-IN

## 12 V SYSTEM

Design: Ralf Keferstein

### INDIVIDUELLE WÜNSCHE INKLUSIVE

PLUG-IN ist ein zierliches, wandelbares 12 Volt Steckkontakt-system. Ähnlich dem Prinzip von Stecker und Steckdose werden die PLUG-IN Leuchten mit den dazugehörigen Steckkontakt-buchsen verbunden. Die Steckverbindung ist jederzeit lösbar und ermöglicht es, die Leuchten beliebig zu kombinieren.

Je nach Montagesituation und geplanter Elektroinstallation bietet das System verschiedene optische Möglichkeiten. Hochwertige Designgehäuse sind für die Aufbaumontage bestimmt.

Steckkontaktbuchsen für den Einbau in abgehängte Decken bieten die Möglichkeit zur Gestaltung individuell angepasster Lichtkonzepte.

Das PLUG-IN System setzt dekorative Akzente und empfiehlt sich gleichermaßen für den Einsatz im privaten Wohnraum, wie auch für den Shop- und Objektbereich. Es lässt sich individuell für alle erdenklichen Beleuchtungsanforderungen konfigurieren.

### INDIVIDUAL WISHES INCLUDED

PLUG-IN is a delicate, versatile 12V plug connector system. Much like the principle of plug and plug socket, the PLUG-IN luminaires are connected to the corresponding plug sockets. The plug connection can be detached at any time and allows for combination of the luminaires any way you like.

Depending on the installation situation and planned electrical installation, the system offers a wide variety of optical possibilities. High quality designer housing is intended for surface mounted installation.

Plug sockets for recessed installation in suspended ceilings offer the option of designing individually tailored lighting concepts.

The PLUG-IN system creates decorative accents and is recommended for use both in private living space and for the shop and property sector. It can be individually configured for any lighting requirements imaginable.



GRACE

# ÜBERSICHT OVERVIEW

Strahler und  
Raumlichter  
Spots and  
ambient lights



GATE B FIVE  
214



STREAM 51  
217



MATCH  
217



MX-2  
219



LP 111  
219



BENE DICT  
220

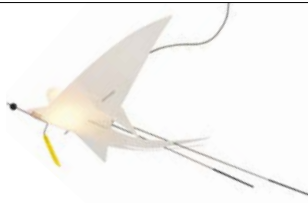

CHARLES  
221

Pendelleuchten  
Pendant  
luminaires



GRACE  
222



PULL-IT  
224



BALINO  
225



BENE  
226



BALIBU  
227



DONATA  
228



COCO  
229

## PLUG-IN INSTALLATION



BENE

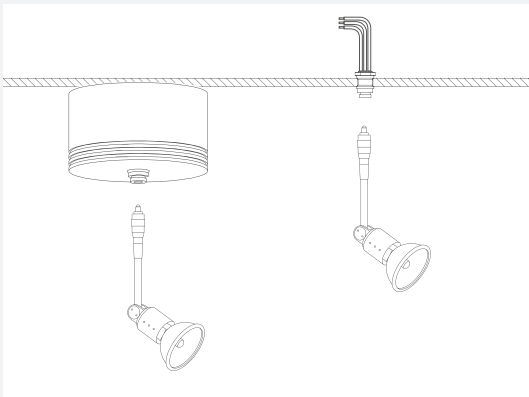

#### FLEXIBLE INSTALLATIONSMÖGLICHKEITEN

Je nach Anwendungsbereich bietet sich eine Einbau- oder Aufbau- montage an. Bei der Einbauvariante verschwindet der externe Transformator in Holraumwand oder -decke. Die Aufbauvariante in Form eines Deckenbaldachins bietet einen integrierten Transformator.

#### FLEXIBLE INSTALLATION OPTIONS

Depending on the area of application, recessed or surface mounting is possible. In the recessed version, the external transformer disappears in suspended ceilings or walls. The surface mounted variant in the form of a ceiling canopy provides an integrated transformer.

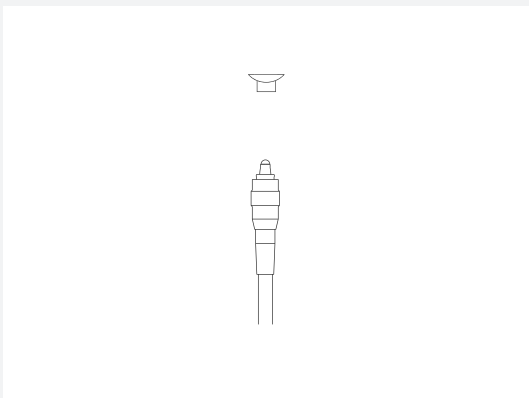

#### EINFACH UND SICHER MONTIEREN

Dank der Steckverbindung lassen sich PLUG-IN Leuchten schnell und komfortabel in Betrieb nehmen. Die werkseitig vorgesehene Koaxialzuleitung bei Pendelleuchten ist grundsätzlich zwei Meter lang und kann bei der Montage nach Belieben am Stecker gekürzt werden.

#### INSTALL EASILY AND SAFELY

Because of the plug-in connection, PLUG-IN luminaires can be put into operation quickly and conveniently. The factory-provided coaxial supply cable for pendant luminaires is basically two metres long and can be shortened at the plug as desired during installation.

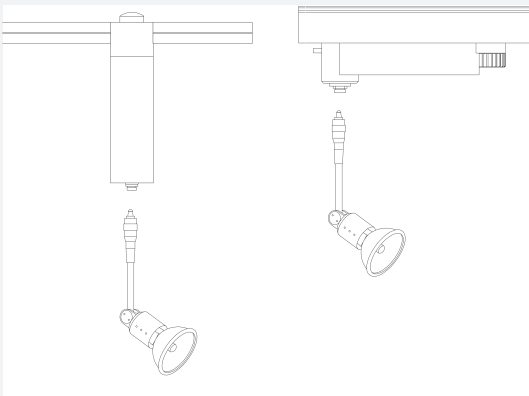

#### HOCHVOLT-SYSTEME

Das Leuchtensortiment aus dem 12 V PLUG-IN System lässt sich über die Adapter CONTACT TUBE und PHASE-IN in die Hochvolt-Schienensysteme CHECK-IN und PHASE einbinden.

#### HIGH-VOLTAGE SYSTEMS

The range of luminaires from the 12 V PLUG-IN system can be integrated into the CHECK-IN and PHASE high-voltage track systems by using the CONTACT TUBE and PHASE-IN adapters.

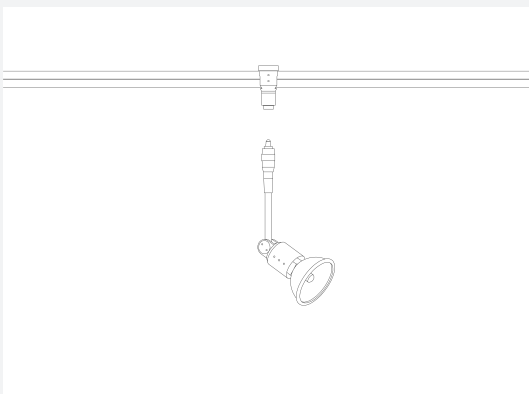

#### NIEDERVOLT-SYSTEM

Der Adapter READY-IN ermöglicht die Kombination mit der filigranen 12 Volt Schiene aus dem System READY FOR TAKE OFF von OLIGO.

#### LOW-VOLTAGE SYSTEM

The READY-IN adapter enables the combination with the delicate 12 volt track from the READY FOR TAKE OFF system by OLIGO.

## GATE B FIVE



GATE B FIVE | GATE B TUBE





EXTERN  
DIMMBAR



FÜR RETROFIT  
GEEIGNET

PLUG-IN

Design: Ralf Keferstein



Chrom matt, 50 mm  
Matt chrome, 50 mm

Chrom matt, 140 mm  
Matt chrome, 140 mm

GATE B FIVE

Strahler

Drehbar, schwenkbar

Metall

Spotlight

Rotatable, tiltable

Metal

GATE B FIVE | 50 mm

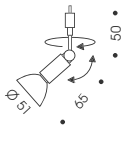

12 V 0,1 kg

GATE B FIVE | 90 mm

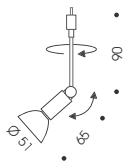

12 V 0,1 kg

GU 5,3 | QR-CBC 51 Halogen max. 35/50 W | Retrofit

Leuchte Luminaire	Länge Length	Leistung Power	Artikel Item
Chrom Chrome	50 mm	max. 35 W	13-974-10-05
Chrom matt Matt chrome			13-974-10-06
Chrom Chrome	90 mm	max. 50 W	13-974-11-05
Chrom matt Matt chrome			13-974-11-06

Adapter separat bestellen ab Seite 232, Leuchtmittelzubehör GATE B TUBE siehe unten, weiteres Zubehör ab Seite 244  
Order adapter separately from page 232, GATE B TUBE accessory see below, further accessories from page 244

GATE B TUBE

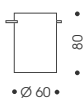

0,1 kg

OPTION: GATE B TUBE

Typ Type	Farbe Colour	Artikel Item
Glasschirm Glass shade	Teilsatiniert Partially satinised	62-111-11-01

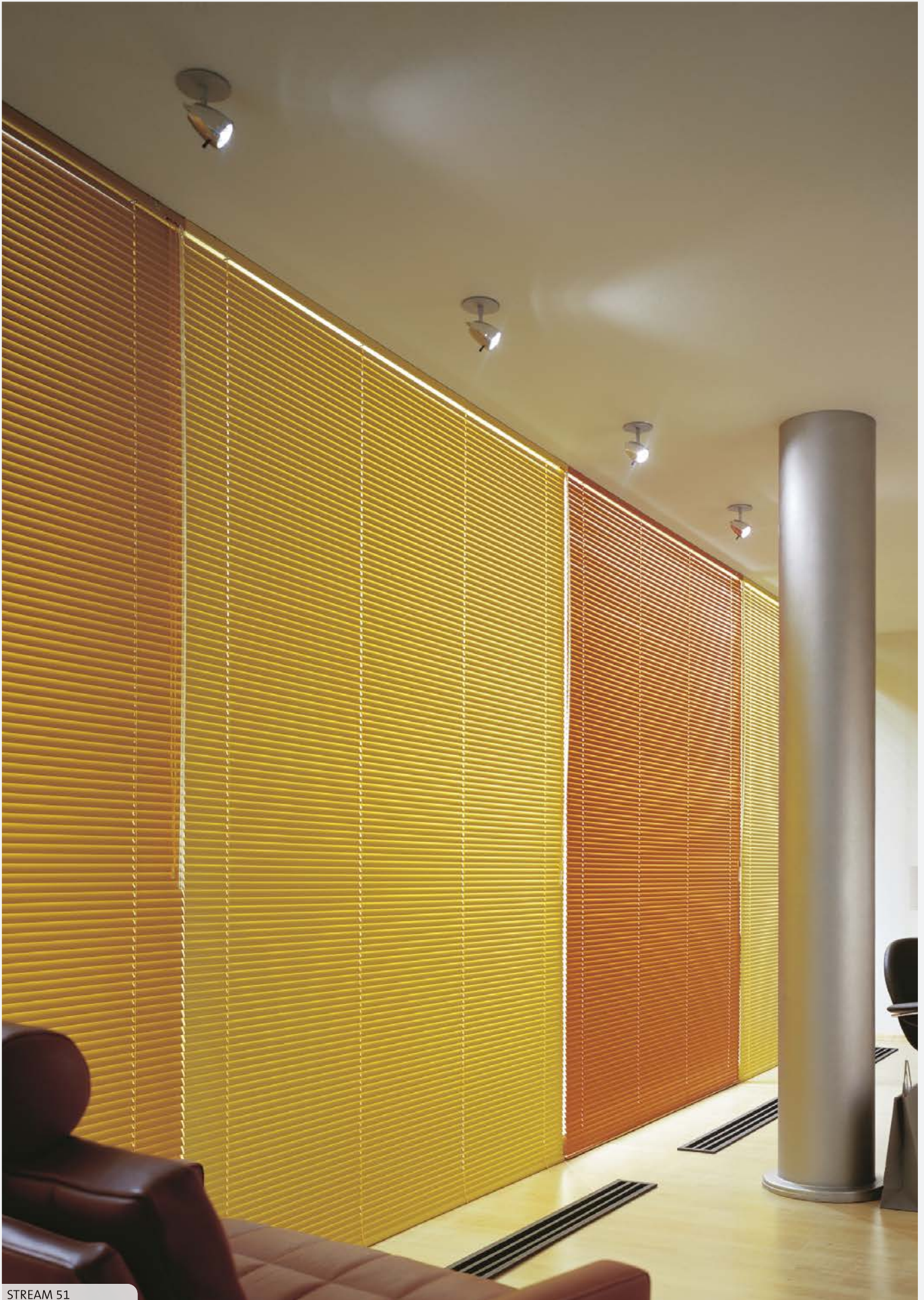

STREAM 51



EXTERN  
DIMMBAR



FÜR RETROFIT  
GEEIGNET

PLUG-IN

# STREAM 51

Design: Ralf Keferstein



Chrom  
Chrome



Chrom matt  
Matt chrome

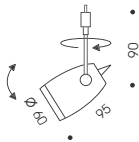

12 V 0,3 kg

## Strahler

Drehbar, schwenkbar

Halogen: "Cool beam" Leuchtmittel nicht zulässig

Retrofit: Gesamtlänge ≤48 mm empfohlen

Metall

## Spotlight

Rotatable, tiltable

Halogen: "Cool beam" lamp not permitted

Retrofit: total length ≤48 mm recommended

Metal

GU 5,3 | QR-C 51 Halogen max. 50 W | Retrofit

Leuchte Luminaire	Artikel Item
Chrom Chrome	13-945-11-05
Chrom matt Matt chrome	13-945-11-06

Adapter separat bestellen ab Seite 232  
Order adapter separately from page 232

# MATCH



Chrom  
Chrome



Chrom matt  
Matt chrome

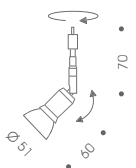

12 V 0,2 kg

## Strahler

Drehbar / schwenkbar

Metall

## Spotlight

Rotatable, tiltable

Metal

GU 5,3 | QR-CBC 51 Halogen max. 50 W | Retrofit

Leuchte Luminaire	Artikel Item
Chrom Chrome	13-892-10-05
Chrom matt Matt chrome	13-892-10-06

Adapter separat bestellen ab Seite 232, Leuchtmittelzubehör ab Seite 244  
Order adapter separately from page 232, Lamp accessories from page 244

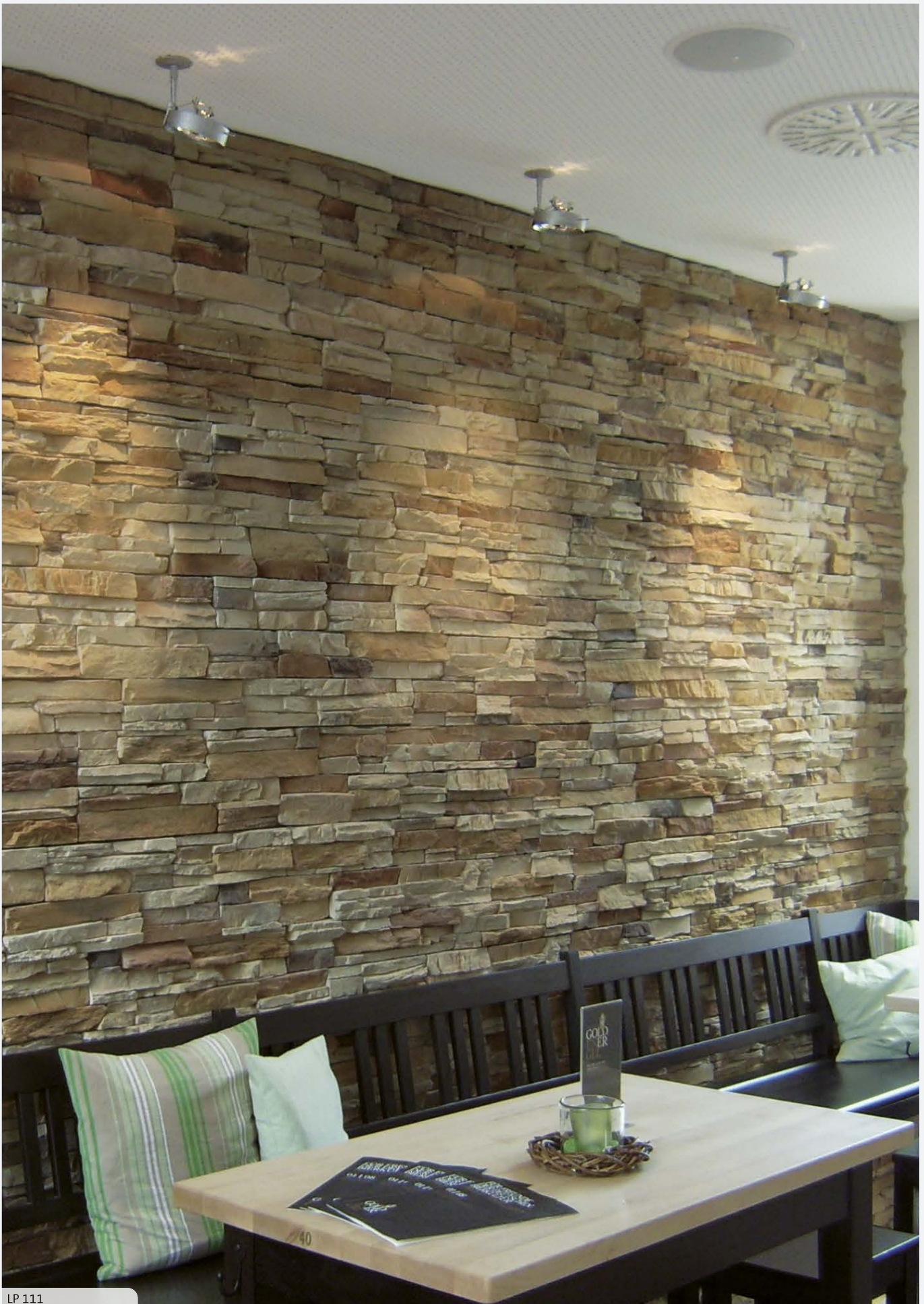

LP 111



EXTERN  
DIMMBAR



FÜR RETROFIT  
GEEIGNET

PLUG-IN

# MX-2

Design: Ralf Keferstein



Chrom matt  
Matt chrome



Chrom matt, Schirm S1  
Matt chrome, S1 shade

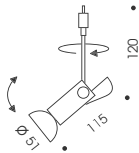

12 V 0,2 kg

Strahler

Drehbar, schwenkbar

Metall

Spotlight

Rotatable, tiltable

Metal

GU 5,3 | QR-CBC 51 Halogen max. 50 W | Retrofit

Leuchte Luminaire	Artikel Item
Chrom matt Matt chrome	13-959-10-06

Adapter separat bestellen ab Seite 232, Leuchtmittelzubehör ab Seite 244  
Order adapter separately from page 232, Lamp accessories from page 244

# LP 111

Design: Ralf Keferstein



Chrom matt  
Matt chrome

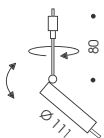

12 V 0,2 kg

Strahler

Drehbar, schwenkbar

Metall

Spotlight

Rotatable, tiltable

Metal

G 53 | QR-LP 111 Halogen max. 50 W | Retrofit

Leuchte Luminaire	Artikel Item
Chrom matt Matt chrome	13-934-10-06

Adapter separat bestellen ab Seite 232  
Order adapter separately from page 232

12 V SYSTEM



EXTERN  
DIMMBAR



FÜR RETROFIT  
GEEIGNET

# BENE DICT

Design: Ralf Keferstein



Weiß matt  
Matt white

Raumlicht

Aluminium, Borosilikatglas

Ambient light

Aluminium, Borosilicate glass

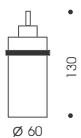

12 V 0,3 kg

GY 6,35 | QT-LP 12 Halogen max. 35 W | Retrofit

Leuchte Luminaire

Artikel Item

Chrom matt  
Matt chrome

13-935-20-06/21

Adapter separat bestellen ab Seite 232  
Order adapter separately from page 232



EXTERN  
DIMMBAR



FÜR RETROFIT  
GEEIGNET

PLUG-IN

# CHARLES

Design: Ralf Keferstein



Weiß matt  
Matt white

## Raumlicht

Metall, temperaturbeständige Folie, Abhängung biegsame Koaxiallitze

## Ambient light

Metal, temperature-resistant foil, suspension flexible coaxial cable

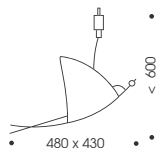

12 V 0,3 kg

GY 6,35 | QT-LP 12 Halogen max. 50 W | Retrofit

Leuchte Luminaire

Artikel Item

Weiß matt  
Matt white

13-986-10-05

Adapter separat bestellen ab Seite 232  
Order adapter separately from page 232

# GRACE







EXTERN  
DIMMBAR



FÜR RETROFIT  
GEEIGNET

PLUG-IN

Design: Ralf Keferstein



Chrom  
Chrome



Aluminium gebürstet  
Brushed aluminium

### Pendelleuchte

Kürzbar  
Abhängung auf Anfrage bis 5 m erhältlich

Metall, Glas

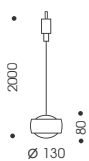

12 V 0,6 kg

### Pendant luminaire

Can be shortened  
Suspension available up to 5 m on request

Metal, glass

GY 6,35 | QT-LP 12 Halogen max. 50 W | Retrofit

Leuchte Luminaire	Artikel Item
Chrom Chrome	13-931-10-05
Aluminium gebürstet Brushed aluminium	13-931-10-12

Adapter separat bestellen ab Seite 232  
Order adapter separately from page 232

12 V SYSTEM



EXTERN  
DIMMBAR



FÜR RETROFIT  
GEEIGNET

# PULL-IT

Design: Ralf Keferstein



Weiß matt  
Matt white

Transparent  
Transparent

## Pendelleuchte

Kürzbar  
Abhängung auf Anfrage bis 5 m erhältlich

Metall, Glas

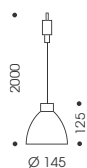

12 V 1,1 kg

## Pendant luminaire

Can be shortened  
Suspension available up to 5 m on request

Metal, glass

GY 6,35 | QT-LP 12 Halogen max. 50 W | Retrofit

Korpus Body	Schirm Shade	Artikel Item
Chrom matt Matt chrome	Weiß matt Matt white	13-952-10-06/21
Chrom matt Matt chrome	Transparent	13-952-10-06/01

Adapter separat bestellen ab Seite 232  
Order adapter separately from page 232



EXTERN  
DIMMBAR



FÜR RETROFIT  
GEEIGNET

PLUG-IN

# BALINO



**Chrom, Satiniert**  
Chrome, Satin



**Chrom, Orange**  
Chrome, Orange



**Chrom matt, Satiniert**  
Matt chrome, Satin



**Chrom matt, Tabak**  
Matt chrome, Tobacco



**Chrom matt, Gold**  
Matt chrome, Gold

## Pendelleuchte

Kürzbar  
Abhängung auf Anfrage bis  
5 m erhältlich

Metall, Glas

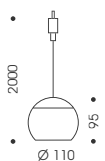

12 V 0,5 kg

## Pendant luminaire

Can be shortened  
Suspension available up to  
5 m on request

Metal, glass

GY 6,35 | QT-LP 12 Halogen max. 35 W | Retrofit

Haube Cap	Schirm Shade	Artikel Item
Chrom Chrome	Satiniert	13-880-10-05/03
Chrom Chrome	Orange glänzend	13-880-10-05/29
Chrom matt Matt chrome	Satiniert	13-880-10-06/03
Chrom matt Matt chrome	Tabak glänzend	13-880-10-06/40
Chrom matt Matt chrome	Gold glänzend	13-880-10-06/08

Adapter separat bestellen ab Seite 232  
Order adapter separately from page 232

12 V SYSTEM



EXTERN  
DIMMBAR



FÜR RETROFIT  
GEEIGNET

# BENE

Design: Ralf Keferstein



Weiß matt  
Matt white

## Pendelleuchte

Kürzbar  
Abhängung auf Anfrage bis 5 m erhältlich

Metall, Glas

## Pendant luminaire

Can be shortened  
Suspension available up to 5 m on request

Metal, glass

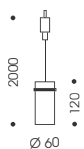

12 V 0,3 kg

GY 6,35 | QT-LP 12 Halogen max. 50 W | Retrofit

Leuchte Luminaire

Artikel Item

Weiß matt  
Matt white

13-935-10-06/21

Adapter separat bestellen ab Seite 232  
Order adapter separately from page 232



EXTERN  
DIMMBAR



FÜR RETROFIT  
GEEIGNET

PLUG-IN

# BALIBU

Design: Ralf Keferstein

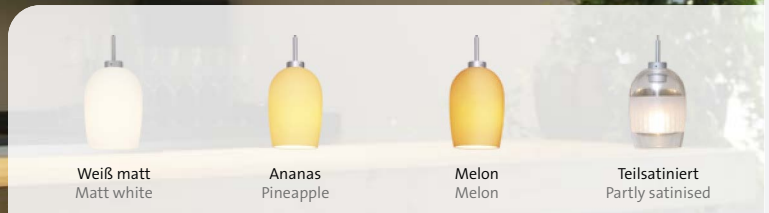
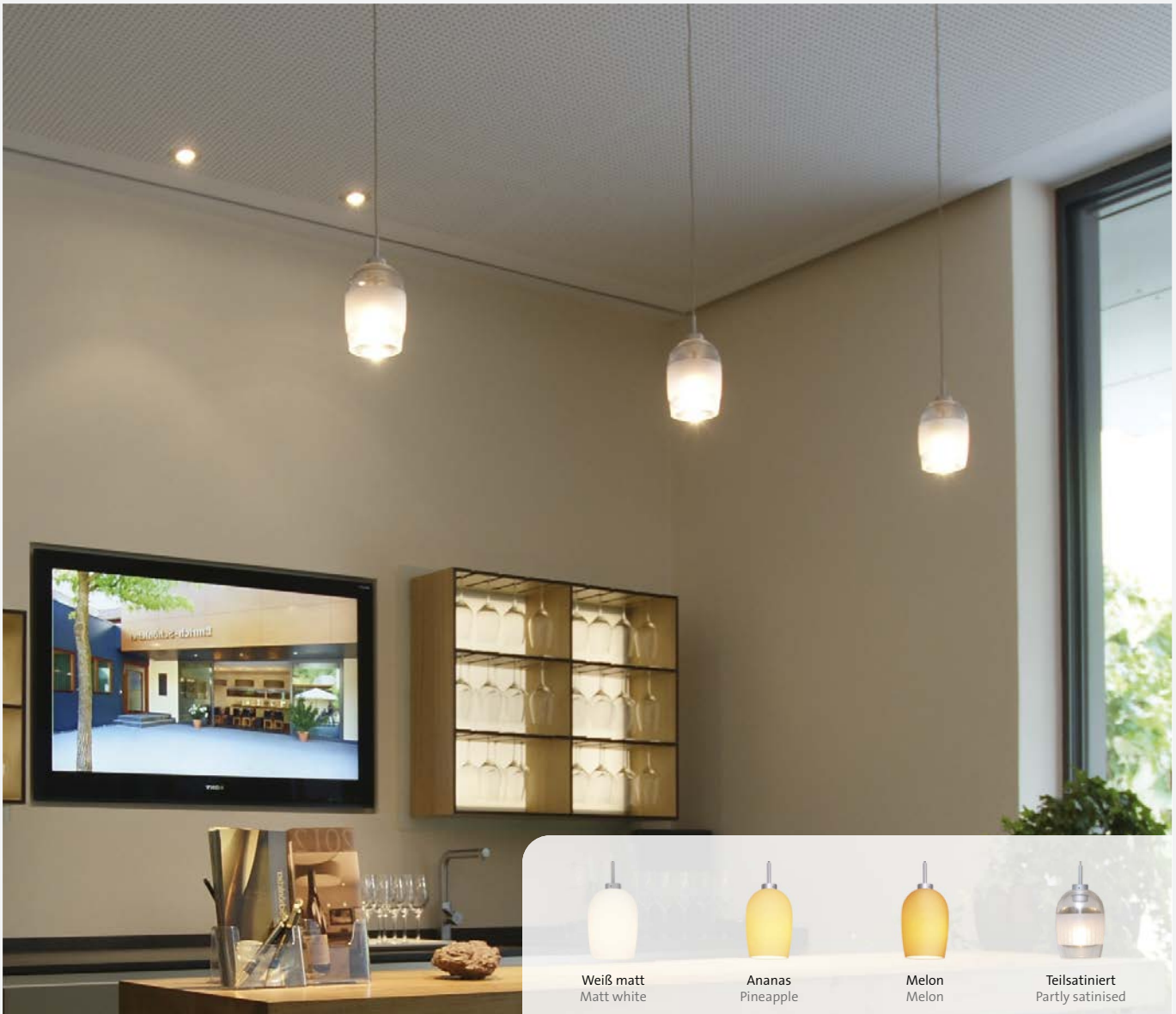

## Pendelleuchte

Kürzbar  
Abhängung auf Anfrage bis 5 m erhältlich

Metall, Glas mundgeblasen

## Pendant luminaire

Can be shortened  
Suspension available up to 5 m on request

Metal, hand-blown glass

GU 5,3 | QR-CBC 51 Halogen max. 50 W  
GY 6,35 | QT-LP 12 Halogen max. 50 W | Retrofit

Korpus Body	Schirm Shade	Fassung Socket	Artikel Item
Chrom matt Matt chrome	Teilsatiniert Partly satinised	GU 5,3	13-991-11-06/02
Chrom matt Matt chrome	Weiß matt Matt white	GY 6,35	13-991-10-06/21
Chrom matt Matt chrome	Ananas Pineapple		13-991-10-06/32
Chrom matt Matt chrome	Melon Melon		13-991-10-06/28

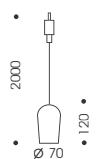

12 V 0,4 kg

Adapter separat bestellen ab Seite 232  
Order adapter separately from page 232

12 V SYSTEM



EXTERN  
DIMMBAR



FÜR RETROFIT  
GEEIGNET

# DONATA

Design: Ralf Keferstein



## Pendelleuchte

Kürzbar  
Abhängung auf Anfrage bis 5 m erhältlich

Metall, Glas mundgeblasen

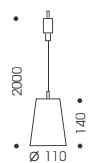

12 V 0,6 kg

## Pendant luminaire

Can be shortened  
Suspension available up to 5 m on request

Metal, hand-blown glass

GY 6,35 | QT-LP 12 Halogen max. 50 W | Retrofit

Korpus Body	Schirm Shade	Artikel Item
Chrom matt Matt chrome	Weiß matt Matt white	13-909-20-06/21
Chrom matt Matt chrome	Champagner Champagne	13-909-20-06/42

Adapter separat bestellen ab Seite 232  
Order adapter separately from page 232



EXTERN  
DIMMBAR



FÜR RETROFIT  
GEEIGNET

PLUG-IN

COCO

Design: Ralf Keferstein



Weiß matt  
Matt white



Melon  
Melon

Pendelleuchte

Kürzbar

Abhängung auf Anfrage bis 5 m erhältlich

Metall, Glas mundeblasen

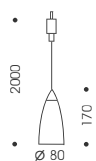

12 V 0,4 kg

Pendant luminaire

Can be shortened

Suspension available up to 5 m on request

Metal, hand-blown glass

GY 6,35 | QT-LP 12 Halogen max. 50 W | Retrofit

Korpus Body	Schirm Shade	Artikel Item
Chrom matt Matt chrome	Weiß matt Matt white	13-983-10-06/21
Chrom matt Matt chrome	Melon Melon	13-983-10-06/28

Adapter separat bestellen ab Seite 232  
Order adapter separately from page 232

# SYSTEMKOMPONENTEN

## SYSTEM COMPONENTS

Design: Ralf Keferstein

12 V | max. 5 A

Die Komponenten eines Steckkontaktsystems variieren je nach Anwendungssituation und individuellen Anforderungen des Kunden. Die nachfolgende Übersicht bietet eine Übersicht über die verschiedenen Möglichkeiten der Adaption.

The components of a plug-in contact system vary depending on the application situation and the customer's individual requirements. The following overview provides an overview of the various possibilities for adaptation.

Beispiele Examples



### BEISPIELE FÜR ADAPTIONEN

#### EXAMPLES FOR ADAPTATIONS

- A** Steckkontaktbuchse für die Einbaumontage  
Plug-in contact socket for surface mounting  
Designgehäuse für die Aufbau-  
montage  
Design housing for surface  
mounting
- B** Adapter für 12 V Schienen-  
system READY FOR TAKE OFF  
Adapter for 12 V track system  
READY FOR TAKE OFF
- C** Adapter für 230 V Schienen-  
system CHECK-IN  
Adapter for 230 V track system  
CHECK-IN



# TRANSFORMATOREN UND GLEICHSPANNUNGSNETZTEILE

## TRANSFORMERS AND DC POWER SUPPLY UNITS

### Kombinationsmöglichkeiten verschiedener Leuchtmittel- und Transformatortypen

Possible combinations of different lamp and  
transformer types

Magnetischer Transformator Magnetic transformer	VA	Katalogseite Page	Retrofit Leuchtmittel Retrofit lamps	Halogen Leuchtmittel Halogen lamps
LOCAL-A	50	235	•	•
extern, z.B. MT 1 external, i.e. MT 1	105 / ... / 400	241	•	•
<b>Elektronischer Transformator Electronic transformer</b>				
CONTACT TUBE	35-60	235		•
PHASE-IN	20-50	235		•
extern, z.B. ET 5 external, i.e. ET 5	50-150	241		•

### Zulässige Leuchtmittelkombinationen bei mehreren PLUG-IN Buchsen am gleichen magnetischen Transformator

Permissible lamp combinations with several PLUG-IN sockets  
on the same magnetic transformer

	Retrofit Leuchtmittel Retrofit lamps	Halogen Leuchtmittel Halogen lamps
Retrofit Leuchtmittel Retrofit lamps	•	•
Halogen Leuchtmittel Halogen lamps	•	•

Um die Lebensdauer von Halogen-Leuchtmitteln bei gleichzeitigem Betrieb von LED-Leuchten und / oder Retrofit-Leuchtmitteln nicht negativ zu beeinflussen, sollte eine Auslastung von mindestens 70 % der angegebenen, maximalen Leistung des Transformators gewährleistet sein.

In order to avoid negatively affecting the service life of halogen lamps during simultaneous operation of LED luminaires and / or retrofit lamps, a load of at least 70 % of the specified maximum capacity of the transformer should be ensured.

## STECKKONTAKTBUCHSEN für externe Transformatoren

12 V | max. 5 A

Schutzklasse 3  
Externe Transformatoren ab Seite 240

## PLUG-IN CONTACT SOCKETS for external transformers

12 V | max. 5 A

Protection class 3  
External transformers from page 240



Foto: ARTMIX

IN-B | DONATA

### 1.1 IN-A



Ø 15 mm, rückseitige Verschraubung, Einbauöffnung Ø 13 mm  
Für Trockenbau mit Plattenstärken von 1 bis 10 mm  
Metall

Ø 15 mm, screw connection on the back, Installation opening Ø 13 mm  
For drywall with panel thicknesses from 1 to 10 mm  
Metal

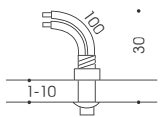

### 1.2 IN-A



Ø 20 mm, rückseitige Verschraubung, Einbauöffnung Ø 13 mm  
Für Trockenbau mit Plattenstärken von 3 bis 25 mm  
Nicht geeignet für die Montage auf leitenden Materialien  
Metall

Ø 20 mm, screw connection at the back, Installation opening Ø 13 mm  
Not suitable for mounting on conductive materials  
For drywall with panel thicknesses from 3 to 25 mm  
Metal

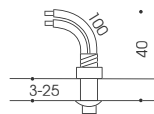

Farbe	Colour	Artikel Item
Chrom	Chrome	14-401-10-05

Farbe	Colour	Artikel Item
Chrom	Chrome	14-401-11-05

2.1 IN-B



Ø 40 mm, Einbauöffnung Ø 32 mm  
Für die Montage mittels Blattfeder bei Plattenstärken von 11 – 30 mm  
Bei Montage auf Gipskartonplatten Leuchtengewicht max. 0,8 kg  
Metall

Ø 40 mm, Installation opening Ø 32 mm  
For mounting by means of leaf spring for panel thicknesses of 11 - 30 mm  
For mounting on plasterboard Luminaire weight max. 0.8 kg  
Metal

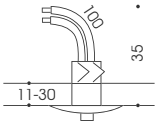

Farbe	Colour	Artikel Item
Chrom	Chrome	14-402-10-05
Chrom matt	Matt chrome	14-402-10-06
Weiß matt	Matt white	14-402-10-21

2.2 IN-B



Ø 70 mm, Einbauöffnung Ø 58 mm  
Nur geeignet für Deckenmontage  
Geeignet zur Abdeckung einer Revisionsöffnung zum Einbau kleiner Schaltnetzteile  
Metall

Ø 70 mm, Installation opening Ø 58 mm  
Only suitable for ceiling mounting  
Suitable for covering an inspection opening for the installation of small switching power supplies  
Metal

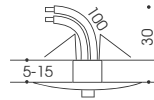

Farbe	Colour	Artikel Item
Chrom	Chrome	21-402-12-05
Chrom matt	Matt chrome	21-402-12-06
Weiß matt	Matt white	21-402-12-21

3. IN-D



Ø 100 mm, Einbauöffnung Ø 25 - 50 mm  
Abdeckplatte für Deckenkaschierung, verdeckte Montageschrauben  
Auch für Beton-Einbaudosen  
Metall

Ø 100 mm, Installation opening Ø 25 - 50 mm  
Cover plate for ceiling lamination, concealed mounting screws  
Also for concrete recessed boxes  
Metal

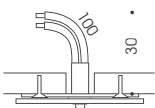

Farbe	Colour	Artikel Item
Chrom	Chrome	21-404-10-05
Chrom matt	Matt chrome	21-404-10-06
Weiß matt	Matt white	21-404-10-21

4. IN-F



Ø 72 x 24 mm  
Aufbau  
Einbauöffnung Ø 10 - 20 mm  
Metall

Surface mounted  
Installation opening Ø 10 - 20 mm  
Metal

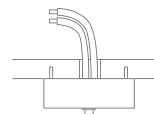

Farbe	Colour	Artikel Item
Chrom	Chrome	14-405-10-05
Chrom matt	Matt chrome	14-405-10-06

## BALDACHINE UND SYSTEMADAPTER

Designgehäuse mit integriertem Transformator für die  
Anwendung als Einzelleuchte

Systemadapter für Schienensysteme

## CANOPIES AND SYSTEM ADAPTERS

Design housing with integrated transformer for use  
as a single luminaire

System adapter for track systems



5. LOCAL-A



Ø 87 x 49 mm

230-240 V | 50-60 Hz | 12 V | 50 VA

**Aufbau**  
 Magnetischer Transformator SELV  
 Kompatibel mit Dimmer "Typ L"  
 Auch geeignet für 12 V Leuchten mit LED-Retrofit Leuchtmittel  
 Schutzklasse 1  
 Metall

Surface mounted  
 Magnetic transformer SELV  
 Compatible with "Type L" dimmer  
 Also suitable for 12 V luminaires with LED retrofit lamps  
 Protection class 1  
 Metal

Farbe	Colour	Artikel Item
Chrom	Chrome	14-414-10-05
Chrom matt	Matt chrome	14-414-10-06
Weiß matt	Matt white	14-414-10-21

6.1 PHASE-IN



1x 20-50 VA

Elektronischer Transformator  
 Sekundärseitig zulässige Leitungslänge <2m  
 Kompatibel mit Dimmer "Typ C"

Kompatibel mit Schienensystem PHASE

Electronic transformer  
 Permissible cable length on secondary side <2m  
 Compatible with "Type C" dimmer

Compatible with PHASE track system

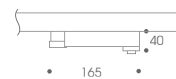

Farbe	Colour	Artikel Item
Chrom matt	Matt chrome	33-621-10-06
Weiß matt	Matt white	33-621-10-21

6.2 CONTACT



1x 35-60 VA

Elektronischer Transformator  
 Sekundärseitig zulässige Leitungslänge <2m  
 Kompatibel mit Dimmer "Typ C"

Kompatibel mit Schienensystem CHECK-IN

Electronic transformer  
 Permissible cable length on secondary side <2m  
 Compatible with "Type C" dimmer

Compatible with CHECK-IN track system

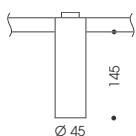

Farbe	Colour	Artikel Item
Chrom	Chrome	31-621-10-05
Chrom matt	Matt chrome	31-621-10-06

6.3 READY-IN



max. 5 A

Kompatibel mit Schienensystem READY FOR TAKE OFF

Je nach Spannungsversorgung des Gesamtsystems geeignet für 12 V Halogen Leuchten oder für Leuchten mit 12 V Retrofit Leuchtmittel

Compatible with READY FOR TAKE OFF track system

Suitable for 12 V halogen luminaires or for luminaires with 12 V retrofit lamps, depending on the voltage supply of the overall system

Farbe	Colour	Artikel Item
Chrom	Chrome	12-621-10-05
Chrom matt	Matt chrome	12-621-10-06



# HLG-120H-24

• INPUT: 100-240VAC 1.4A 50/60Hz  
 277VAC 0.55A 50/60Hz  
 (277VAC for North America only)

• OUTPUT: +24V  $\approx$  5.0A

t<sub>c</sub>:80°C  
 t<sub>a</sub>:60°C

V-(BLACK) ○

V+(RED) ○



Suitable for use in Dry, Damp and Wet Locations



λ:0.95 For operation with LED modules only

MADE IN TAIWAN

KYOWA CO., LTD.

# ZUBEHÖR ACCESSORIES

## SMARTHOME UND DIMMER

Zubehör für die digitale Lichtsteuerung

Mehr zu Casambi und HomeMatic auf Seite 19

## SMARTHOME AND DIMMER

Adapter for digital lighting control

More about Casambi and HomeMatic on page 19

### 1.1 CASAMBI XPRESS



90 x 90 x 12 mm  
2,4 GHz Bluetooth 4.0 LE Casambi

Funktaster zur Wandmontage und/oder als Funkfernbedienung nutzbar, vier programmierbare Tasten. Zum kabellosen Schalten und Dimmen kompatibler Leuchten, auch in Gruppen oder Szenen.

Kunststoff

Mobile switch for wireless switching and dimming of compatible luminaires, including in groups or scenes. Four programmable buttons. Optional wall mounting.

Plastic

Farbe	Colour	Artikel Item
Weiß matt	Matt white	60-626-10-21
Schwarz matt	Matt black	60-626-10-23

### 1.2 CASAMBI INTERFACE

Ø 53 x 21 mm  
230 V AC | 50 Hz | max. 10 A  
2,4 GHz Bluetooth 4.0 LE

Unterputz Tasterinterface

Eingabemodul für bis zu vier potentialfreie Taster. Anwendung entweder mit 4-fach Tastereinsatz oder einer Kombination aus Einzel- und/oder Doppeltastern in mehreren UP-Dosen. Kompatibel mit zahlreichen Standardtastern. Die Funktion der Taster wird in der Casambi-App konfiguriert.

Leitungslängen max. 300 mm, tiefe UP-Dose empfohlen  
UP-Dosen und Taster nicht enthalten

Kunststoff

Flush-mounted Push button interface

Input module for up to four potential-free buttons. It is either used with a 4-channel push button insert or a combination of single and/or double switches in multiple flush-mounted sockets. The function of the buttons is configured in the Casambi app.

Max. cable lengths: 300 mm. Deep flush-mounted socket recommended. Flush-mounted sockets and buttons are not included.

Plastic

### ANSCHLUSSBEISPIELE CONNECTION EXAMPLES



2x Doppeltaster  
2x double buttons

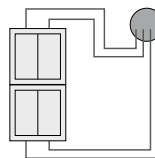

4x Einzeltaster  
4x single buttons

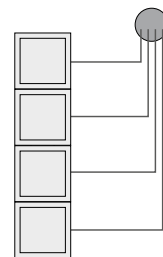

Typ	Type	Artikel Item
Tasterinterface	Push button interface	60-211-40-10





CASAMBI XPRESS

2.1 HOMEMATIC TASTER SWITCH

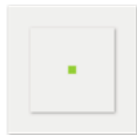

868,3 MHz HomeMatic BidCoS

Funktaster, programmierbar

Zum kabellosen Schalten und Dimmen kompatibler Leuchten, auch in Gruppen oder Szenen.

Kunststoff

Wireless button, programmable

For wireless switching and dimming of compatible luminaires, including in groups or scenes.

Plastic

Farbe	Colour	Artikel Item
Wei matt	Matt white	60-626-11-21

2.2 HOMEMATIC FERNBEDIENUNG REMOTE CONTROL



868,3 MHz HomeMatic BidCoS

Funkfernbedienung, acht programmierbare Tasten

Zum kabellosen Schalten und Dimmen kompatibler Leuchten, auch in Gruppen oder Szenen.

Kunststoff

Wireless remote control, eight programmable buttons

For wireless switching and dimming of compatible luminaires, including in groups or scenes.

Plastic

Farbe	Colour	Artikel Item
Wei matt	Matt white	60-627-11-21

# ZUBEHÖR

Transformatoren, Schaltnetzteile und Dimmer

# ACCESSORIES

Transformers, power switching supply and dimmers

### 3.1 OSRAM MOUSE™



230 V | 50-60 Hz | 12 V

Elektronischer Transformator  
 Sekundärseitig zulässige Leitungslänge <2m  
 Kompatibel mit Dimmer "Typ L" und "Typ C"  
 Schutzklasse 2, ENEC, VDE

Montage in oder auf normal entflammaren  
 Möbelteilen zulässig

Electronic transformer  
 Permissible secondary side cable length <2 m  
 Compatible with "Type L" and "Type C" dimmers  
 Protection class 2, ENEC, VDE

Installation in or on furniture elements with  
 normal flammability permissible

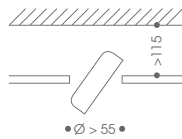
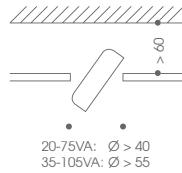

VA	Größe Size	Ausschnitt Cut-out	Artikel Item
20-75	104 x 33 x 22	Ø 40	60-116-10-21
35-105	108 x 52 x 33	Ø 55	60-116-11-21
50-150	153 x 54 x 36	Ø 55	60-116-12-21

### 3.2 ET 4



230 V | 50-60 Hz | 12 V

Elektronischer Flachtransformator  
 Sekundärseitig zulässige Leitungslänge <2m  
 Kompatibel mit Dimmer "Typ C"  
 Schutzklasse 2, ENEC, VDE

Primär 2 Klemmen, Sekundär 3 Klemmen max. 3x 35 W

Electronic flat transformer  
 Permissible secondary side cable length <2 m  
 Compatible with dimmer "Type C"  
 Protection class 2, ENEC, VDE

Primary 2 terminals, secondary 3 terminals max. 3x 35 W

VA	Größe Size	Artikel Item
35-105	175 x 42 x 18	60-112-10-21

3.3 ET 5



230 V | 50-60 Hz | 12 V

Elektronischer Transformator  
 Sekundärseitig zulässige Leitungslänge <2m  
 Kompatibel mit Dimmer "Typ C"  
 Schutzklasse 2

Electronic transformer  
 Permissible secondary side cable length <2 m  
 Compatible with dimmer "Type C"  
 Protection class 2

VA	Größe Size	Artikel Item
50-150	127 x 42 x 30	60-113-13-21

4. MT 1



230 V | 50-60 Hz | 12 V

Magnetischer Transformator  
 Kompatibel mit Dimmer "Typ L"  
 Schutzklasse 2, ENEC

Primär Kabel 300 mm und Glassicherung

Magnetic transformer  
 Compatible with dimmer "Type L"  
 Protection class 2, ENEC

300 mm primary cable and glass fuse

VA	Größe Size	Artikel Item
105	108 x 78 x 80	60-101-10-21
150	130 x 85 x 80	60-101-11-21
200	130 x 85 x 100	60-101-12-21
300	130 x 85 x 100	60-101-13-21
400	175 x 128 x 118	60-101-14-21

5.1 DC 1



100-240 V | 50-60 Hz | 12 V DC

Schaltnetzteil  
 Mit Funktionserdung  
 Schraubklemmen mit Klemmenabdeckung  
 ENEC

Switching power supply  
 With functional earthing  
 Screw terminals with terminal covers  
 ENEC

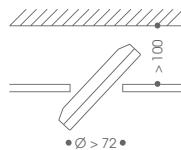

VA	Größe Size	Artikel Item
45	182 x 62 x 35	60-211-11-21
60	182 x 62 x 35	60-211-12-21

5.2 DC 2



100-240 V | 50-60 Hz | 24 V DC

Schaltnetzteil  
 Schutzklasse 1  
 IP 65

Switching power supply  
 With functional earthing  
 Protection class 1  
 IP 65

VA	Größe Size	Artikel Item
60	171 x 62 x 37	60-211-20-06
120	220 x 68 x 39	60-211-21-06
240	244 x 68 x 39	60-211-22-06

5.3 DC 3



100-240 V | 50 Hz | universal

Konstantstrom 350/700/1050 mA  
 Konstantspannung 10 V DC max. 10 W  
 Konstantspannung 12 V DC max. 12 W  
 Konstantspannung 24 V DC max. 20 W  
 Schutzklasse 2, ENEC

Schraubklemmen mit Klemmenabdeckung

Constant current 10 V DC max. 10 W  
 Constant current 12 V DC max. 12 W  
 Constant current 24 V DC max. 20 W  
 Protection class 2, ENEC

Screw terminals with terminal covers

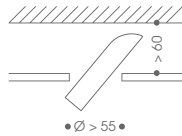

VA	Größe Size	Artikel Item
20	110 x 52 x 24	60-211-10-21

5.4 DC 4



100-277 V | 50-60 Hz | 24 V DC

Schaltnetzteil  
 Schutzklasse 2, ENEC

Steckklemmen mit Klemmenabdeckung

Switching power supply  
 Protection class 2, ENEC

Plug terminals with terminal covers

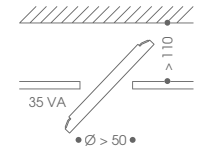

VA	Größe Size	Artikel Item
3,5 - 35	220 x 40 x 21	60-211-23-21
4,8 - 60	250 x 40 x 21	60-211-24-21

5.5 LED DRIVER | CASAMBI



220-240 V | 50-60 Hz | 300 mA | 24-54 V DC | 7,2-16,2 W  
 2,4 GHz Bluetooth 4.0 LE

Konstantstrom, 1x Casambi Modul  
 Schutzklasse 2

Steckklemmen mit Klemmenabdeckung  
 Mit Zugentlastung

Constant current, 1x Casambi module  
 Protection class 2

Plug terminals with terminal covers  
 With strain relief

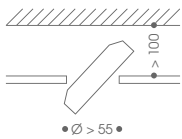

VA	Größe Size	Artikel Item
7,2 - 16,2	157 x 45 x 30	60-211-31-10

6. BUSCH JAEGER LED DIMMER



230 V | 50-60 Hz | 2-100 W

Busch Jaeger 6523 U-102  
 LED-Dimmer UP-Einsatz  
 Mit Drehbetätigung, Druckfolgewechselschalter und Soft-Rastung  
 LED dimmer UP insert  
 With rotary actuation, pressure sequence toggle switch and soft detent

Busch Jaeger 1721-184K  
 1-fach Abdeckrahmen, 80 x 80 x 11 mm, Farbe: Studioweiß  
 Single cover frame, 80 x 80 x 11 mm, colour: Studio white

Busch Jaeger 6540-84-102  
 Zentralscheibe mit Drehknopf und Glimmlampe, Farbe: Studioweiß  
 Central slide with rotary knob and glow lamp, colour: Studio white

Typ Type	Artikel Item
Busch Jaeger Dimmer	60-671-00-00
Set: Dimmer, Rahmen, Drehknopf Set: Dimmer, frame, rotary knob	60-625-00-00



HUBBLE | SMART.POINT



GATE B FIVE | S1

## LEUCHTMITTELZUBEHÖR

Für Halogen bzw. Retrofit Leuchtmittel

## LAMP ACCESSORIES

For halogen or retrofit lamps

KOMPATIBILITÄT COMPATIBILITY					
	R2	S1	S2	S3	A2
GATE B FIVE	•	•		•	•
GATE B FOUR	•				
GATE B SEVEN	•		•	•	•
GATE B SEVEN GALERIE	•		•	•	•
MATCH	•			•	•
MX-2	•	•		•	•
MX-HIGH	•		•	•	•
TAIFUN	•	•		•	•
TORINO	•	•		•	•



GATE B SEVEN | R2

### 7.1 R2 | DEKORING DECORATIVE RING

Design: Ralf Keferstein



Ø 56 x 20mm

Dekoring kompatibel mit Leuchtmitteltyp:  
QR-CBC 51 Halogen oder Retrofit  
QPAR 51 Halogen oder Retrofit

Aluminium

Decorative ring compatible lamp type:  
QR-CBC 51 Halogen oder Retrofit  
QPAR 51 Halogen oder Retrofit

Aluminium

Farbe	Colour	Artikel Item
Chrom	Chrome	62-202-10-05
Chrom matt	Matt chrome	62-202-10-06
Aluminium gebürstet	Brushed aluminium	62-202-10-12

7.2 S1 | SCHIRM SHADE

Design: Ralf Keferstein



Ø 56 x 40 mm

Schirm kompatibel mit Leuchtmitteltyp:  
QR-CBC 51 Halogen

Kompatibel mit nach unten ausgerichteten Leuchtmitteln

Shade compatible lamp type:  
QR-CBC 51 Halogen

Compatible with lamps pointing downwards

Farbe	Material	Colour	Material	Artikel Item
Weiß	Glas	White	Glass	62-211-10-21
Rot	Glas	Red	Glass	62-211-10-25
Ananas	Glas	Pineapple	Glass	62-211-10-32
Gelb	Glas	Yellow	Glass	62-211-10-34
Blau	Glas	Blue	Glass	62-211-10-38
Silber	Metall	Silver	Metal	62-211-11-45

7.3 S2 | SCHIRM SHADE

Design: Ralf Keferstein



Ø 56 x 38 mm

Schirm kompatibel mit Leuchtmitteltyp:  
QPAR 51 Halogen

Kompatibel mit nach unten ausgerichteten Leuchtmitteln

Shade compatible lamp type:  
QPAR 51 Halogen

Compatible with lamps pointing downwards

Farbe	Material	Colour	Material	Artikel Item
Weiß	Glas	White	Glass	62-212-10-21
Silber	Metall	Silver	Metal	62-212-11-45

7.4 S3 | SCHIRM SHADE

Design: Ralf Keferstein



Schirm kompatibel mit Leuchtmitteltyp:  
QR-CBC 51 Halogen oder Retrofit  
QPAR 51 Halogen oder Retrofit

Temperaturbeständige Folie

Shade compatible lamp type:  
QR-CBC 51 Halogen oder Retrofit  
QPAR 51 Halogen oder Retrofit

Temperature-resistant foil

Farbe	Colour	Artikel Item
Weiß	White	62-213-10-21

7.5 A2 | BLENDSCHUTZ ANTI-GLARE

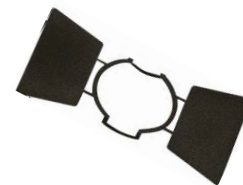

Blendschutzklappen kompatibel mit Leuchtmitteltyp:  
QR-CBC 51 Halogen oder Retrofit  
QPAR 51 Halogen oder Retrofit

Zwei Blendschutzklappen können kombiniert werden

Metall

Anti-glare shutters compatible lamp type:  
QR-CBC 51 Halogen oder Retrofit  
QPAR 51 Halogen oder Retrofit

Two anti-glare shutters can be combined

Metall

Farbe	Colour	Artikel Item
Chrom matt	Matt chrome	62-232-10-06
Schwarz	Black	62-232-10-23





# ANHANG

## APPENDIX

# REGISTER

## NACH PRODUKTNAME

# INDEX

## BY PRODUCT NAME

	SMART.TRACK   SMART.POINT Seite Page 29	CHECK-IN Seite Page 79	PHASE Seite Page 133	READY FOR TAKE OFF Seite Page 171	PLUG-IN Seite Page 209
41 DEGREES	44		149		
A LITTLE BIT	40   52		143   160	177	
A LITTLE BIT MORE	41		143		
AVIATION	37		145		
BALIBU		102			227
BALIBU BEACH		113			
BALINO (Halogen)					225
BALINO (LED)	51				
BENE		113			226
BENE DICT					220
BREAK-IT	60				
B TUBE		99			
CHARLES					221
COCO					229
CONE	59				
CURVED	56				
DECENT	50		157		
DONATA					228
FLAVIA	45		149		
GATE B EIGHT		98			
GATE B FIVE				180	214
GATE B FOUR		97	156		
GATE B NINE				185	
GATE B SEVEN		92	153		
GATE B SEVEN GALERIE		93			
GATE B TWO				187	
GLOBE	57				
GRACE (Halogen)		109		190	222
GRACE (LED)	46	108	158		
HIGH FLIGHT		100			

	SMART.TRACK   SMART.POINT Seite Page 29	CHECK-IN Seite Page 79	PHASE Seite Page 133	READY FOR TAKE OFF Seite Page 171	PLUG-IN Seite Page 209
HIGH STREAM 16		95	155		
HUBBLE	39		141		
ICE		90	152		
JUST KIDDING		101			
KELVEEN	42	86	147		
KENDO L	64				
KENDO M	63				
KENDO S	62				
LEVEL		89	151	178	
LP 111				179	219
MADemoiselle FILOU		105			
MAGIC		105		187	
MATCH		95		183	217
MX-2				185	219
MX-HIGH		96	155		
NABO	58				
NOVA M	65				
NOVA S	65				
PULL-IT		110   111	161	191	224
RIDGE	38		145	176	
RIO	48				
ROCKET		84   106			
SPHERE		85			
SENTRY	36		141		
STREAM 51				183	217
TAIFUN				189	
TORINO				189	
TWIN LANE		89	151		
VERSION B			147		
WALLEY		87			

# REGISTER

## NACH ARTIKELNUMMER

### INDEX

#### BY ITEM NUMBER

Artikel Item	Seite Page	Artikel Item	Seite Page	Artikel Item	Seite Page	Artikel Item	Seite Page
10-931-10-05	109, 190	12-301-11-06	198	12-511-31-05	203	13-991-10-06/32	227
10-931-10-12	109, 190	12-301-12-05	199	12-511-31-06	203	13-991-11-06/02	227
10-952-10-06/01	111, 191	12-301-12-06	199	12-513-10-05	202		
10-952-10-06/21	111, 191	12-301-13-05	199	12-513-10-06	202	14-401-10-05	232
		12-301-13-06	199	12-513-11-05	202	14-401-11-05	232
11-889-21-06	176	12-301-14-05	199	12-513-11-06	202	14-402-10-05	233
11-889-31-06	176	12-301-14-06	199	12-513-20-06	202	14-402-10-06	233
11-898-40-05	177	12-301-15-05	199	12-513-21-06	202	14-402-10-21	233
11-898-40-06	177	12-301-15-06	199	12-601-10-05	201	14-405-10-05	233
11-898-50-05	177	12-301-16-06	199	12-601-10-06	201	14-405-10-06	233
11-898-50-06	177	12-311-10-05	199	12-601-11-23	201	14-414-10-05	235
11-901-10-05	185	12-311-10-06	199	12-621-10-05	195	14-414-10-06	235
11-901-10-06	185	12-321-10-05	199	12-621-10-05	235	14-414-10-21	235
11-905-20-05	183	12-321-10-06	199	12-621-10-06	195		
11-905-20-06	178, 183	12-331-10-05	199	12-621-10-06	235	20-867-60-06	36, 141
11-934-10-06	179	12-331-10-06	199	12-644-10-05	195	20-867-60-21	36, 141
11-943-10-05	189	12-351-10-05	200	12-644-10-06	195	20-867-60-23	36, 141
11-943-10-06	189	12-351-10-06	200			20-867-61-06	36, 141
11-944-10-06	189	12-401-10-05	200	13-880-10-05/03	225	20-867-61-21	36, 141
11-944-11-05	189	12-401-11-05	200	13-880-10-05/29	225	20-867-61-23	36, 141
11-944-11-06	189	12-403-10-05	200	13-880-10-06/03	225	20-867-70-06	36, 141
11-945-10-05	183	12-411-10-05	200	13-880-10-06/08	225	20-867-70-21	36, 141
11-945-10-06	183	12-411-10-06	200	13-880-10-06/40	225	20-867-70-23	36, 141
11-959-10-06	185	12-411-11-05	200	13-892-10-05	217	20-867-71-06	36, 141
11-959-20-06	185	12-411-11-06	200	13-892-10-06	217	20-867-71-21	36, 141
11-959-30-06	185	12-421-10-05	201	13-909-20-06/21	228	20-867-71-23	36, 141
11-961-10-05/21	187	12-421-10-06	201	13-909-20-06/42	228	20-869-20-06	43, 147
11-961-10-06/21	187	12-431-10-06	201	13-931-10-05	223	20-869-20-21	43, 147
11-972-10-06/21	187	12-461-10-05	201	13-931-10-12	223	20-869-20-23	43, 147
11-972-10-06/32	187	12-461-10-06	201	13-934-10-06	219	20-869-21-06	43, 147
11-974-10-05	181	12-501-10-05	203	13-935-10-06/21	226	20-869-21-21	43, 147
11-974-10-06	181	12-501-10-06	203	13-935-20-06/21	220	20-869-21-23	43, 147
11-974-11-05	181	12-501-11-05	203	13-945-11-05	217	20-869-30-06	43, 147
11-974-11-06	181	12-501-11-06	203	13-945-11-06	217	20-869-30-21	43, 147
		12-501-12-05	203	13-952-10-06/01	224	20-869-30-23	43, 147
12-201-10-05	193, 198	12-501-12-06	203	13-952-10-06/21	224	20-869-31-06	43, 147
12-201-10-06	193, 198	12-511-10-05	202	13-959-10-06	219	20-869-31-21	43, 147
12-201-11-05	193, 198	12-511-10-06	202	13-974-10-05	215	20-869-31-23	43, 147
12-201-11-06	193, 198	12-511-11-05	202	13-974-10-06	215	20-870-10-21	45, 149
12-211-10-05	198	12-511-11-06	202	13-974-11-05	215	20-870-10-23	45, 149
12-211-10-06	198	12-511-20-05	202	13-974-11-06	215	20-870-10-23	45, 149
12-211-11-05	198	12-511-20-06	202	13-983-10-06/21	229	20-870-11-21	45, 149
12-211-11-06	198	12-511-21-05	203	13-983-10-06/28	229	20-870-11-23	45, 149
12-301-10-05	198	12-511-21-06	203	13-986-10-05	221	20-870-11-23	45, 149
12-301-10-06	198	12-511-30-05	203	13-991-10-06/21	227	20-870-12-21	45, 149
12-301-11-05	198	12-511-30-06	203	13-991-10-06/28	227	20-870-12-23	45, 149

Artikel Item	Seite Page	Artikel Item	Seite Page	Artikel Item	Seite Page	Artikel Item	Seite Page
20-870-12-23	45, 149	20-889-20-23	38, 145	22-861-20-15	49	23-201-20-21	70
20-870-13-21	45, 149	20-889-21-06	38, 145	22-861-20-21	49	23-201-20-23	70
20-870-13-23	45, 149	20-889-22-21	38, 145	22-861-20-23	49	23-201-22-06	70
20-870-13-23	45, 149	20-889-30-23	38, 145	22-861-20-25	49	23-201-22-21	70
20-870-18-21	45, 149	20-889-31-06	38, 145	22-861-20-36	49	23-201-22-23	70
20-870-18-23	45, 149	20-889-32-21	38, 145	22-861-20-38	49	23-301-10-06	70
20-870-18-23	45, 149	20-898-20-05	53, 160	22-861-20-41	49	23-301-10-21	70
20-870-19-21	45, 149	20-898-20-06	53, 160	22-861-20-48	49	23-301-10-23	70
20-870-19-23	45, 149	20-898-30-05	53, 160	22-861-30-06	49	23-401-10-00	70
20-870-19-23	45, 149	20-898-30-06	53, 160	22-861-30-15	49	23-401-20-00	70
20-871-10-06	44, 149	20-898-40-05	40, 143	22-861-30-21	49	23-421-10-06	71
20-871-10-21	44, 149	20-898-40-06	40, 143	22-861-30-23	49	23-421-10-21	71
20-871-10-23	44, 149	20-898-50-05	40, 143	22-861-30-25	49	23-421-10-23	71
20-871-11-06	44, 149	20-898-50-06	40, 143	22-861-30-36	49	23-421-20-06	71
20-871-11-21	44, 149			22-861-30-38	49	23-421-20-21	71
20-871-11-23	44, 149	21-401-10-05	74	22-861-30-41	49	23-421-20-23	71
20-872-20-06	39, 141	21-401-11-05	74	22-861-30-48	49	23-431-10-06	71
20-872-20-21	39	21-402-10-05	74	22-872-20-06	39	23-431-10-21	71
20-872-20-21	141	21-402-10-06	74	22-872-20-21	39	23-431-10-23	71
20-872-20-23	39	21-402-10-21	74	22-872-20-23	39	23-451-10-06	70
20-872-20-23	141	21-402-12-05	75	22-872-30-06	39	23-451-10-21	70
20-872-30-06	39, 141	21-402-12-05	233	22-872-30-21	39	23-451-10-23	70
20-872-30-21	39	21-402-12-06	75	22-872-30-23	39	23-451-20-06	70
20-872-30-21	141	21-402-12-06	233	22-880-10-06/03	51	23-451-20-21	70
20-872-30-23	39	21-402-12-21	75	22-880-10-06/08	51	23-451-20-23	70
20-872-30-23	141	21-402-12-21	233	22-880-10-06/40	51	23-461-10-06	71
20-875-60-06	37, 145	21-404-10-05	75	22-880-20-05/03	51	23-461-10-21	71
20-875-60-21	37, 145	21-404-10-05	233	22-880-20-05/29	51	23-461-10-23	71
20-875-60-23	37, 145	21-404-10-06	75	22-880-20-05/44	51	23-512-10-06	71
20-875-61-06	37, 145	21-404-10-06	233	22-880-20-06/03	51	23-512-10-21	71
20-875-61-21	37, 145	21-404-10-21	75	22-880-20-06/08	51	23-512-10-23	71
20-875-61-23	37, 145	21-404-10-21	233	22-880-20-06/40	51	23-512-20-06	71
20-875-70-06	37, 145	21-453-10-05	75	22-880-30-05/03	51	23-512-20-21	71
20-875-70-21	37, 145	21-453-10-06	75	22-880-30-05/29	51	23-512-20-23	71
20-875-70-23	37, 145	21-453-10-21	75	22-880-30-05/44	51	23-512-30-06	71
20-875-71-06	37, 145			22-880-30-06/03	51	23-512-30-21	71
20-875-71-21	37, 145	22-861-10-06	49	22-880-30-06/08	51	23-512-30-23	71
20-875-71-23	37, 145	22-861-10-15	49	22-880-30-06/40	51	23-512-40-06	71
20-882-40-23	41, 143	22-861-10-21	49			23-512-40-21	71
20-882-41-05	41, 143	22-861-10-23	49	23-201-10-06	70	23-512-40-23	71
20-882-42-06	41, 143	22-861-10-25	49	23-201-10-21	70	23-512-50-06	71
20-882-43-21	41, 143	22-861-10-36	49	23-201-10-23	70	23-512-50-21	71
20-882-50-23	41, 143	22-861-10-38	49	23-201-12-06	70	23-512-50-23	71
20-882-51-05	41, 143	22-861-10-41	49	23-201-12-21	70	23-601-10-06	72
20-882-52-06	41, 143	22-861-10-48	49	23-201-12-23	70	23-601-10-21	72
20-882-53-21	41, 143	22-861-20-06	49	23-201-20-06	70	23-601-10-23	72

Artikel Item	Seite Page	Artikel Item	Seite Page	Artikel Item	Seite Page	Artikel Item	Seite Page
23-623-10-06	69	30-958-10-06	96	31-311-10-06	125	31-501-13-06	127
23-623-10-21	69	30-961-10-06/21	105	31-321-10-06	126	31-502-10-05	130
23-623-10-23	69	30-964-10-06/21	101	31-322-10-05	129	31-502-10-06	130
23-625-10-06	76	30-968-10-05	95	31-322-10-06	129	31-502-11-05	130
23-625-10-21	76	30-968-11-06	95	31-322-12-05	129	31-502-11-06	130
23-625-10-23	76	30-969-10-06	100	31-322-12-06	129	31-502-12-05	130
23-625-11-06	76	30-969-11-06	100	31-331-10-05	126	31-502-12-06	130
23-625-11-21	76	30-969-20-06	100	31-331-10-06	126	31-502-13-06	130
23-625-11-23	76	30-969-21-06	100	31-332-10-05	129	31-512-10-05	131
23-627-10-06	69	30-973-10-05	92	31-332-10-06	129	31-512-10-06	131
23-627-10-21	69	30-973-10-06	92	31-332-12-06	129	31-512-11-05	131
23-627-10-23	69	30-973-11-05	92	31-351-10-06	126	31-512-11-06	131
23-627-11-06	69	30-973-11-06	92	31-351-11-06	131	31-512-12-06	131
23-627-11-21	69	30-973-20-05	93	31-352-10-06	129	31-521-10-06	131
23-627-11-23	69	30-973-20-06	93	31-401-10-05	126	31-601-10-01	128
23-651-10-06	70	30-980-10-23	105	31-401-10-06	126	31-601-10-06	128
23-651-10-21	70	30-991-10-05/21	103	31-401-11-05	126	31-602-10-05	130
23-651-10-23	70	30-991-10-06/21	103	31-401-11-06	126	31-602-11-06	130
23-661-10-21	72	30-991-10-06/28	103	31-411-10-05	126	31-621-10-05	115
		30-991-10-06/32	103	31-411-10-06	126	31-621-10-05	235
30-852-10-05	85	30-991-11-05/02	103	31-411-11-06	126	31-621-10-06	115
30-852-10-06	85	30-991-11-06/02	103	31-412-10-06	128	31-621-10-06	235
30-853-10-05	84	30-991-20-06/21	113	31-412-11-05	128	31-641-10-06	115
30-853-10-06	84	30-993-10-05	99	31-412-11-06	128	31-990-10-06	118
30-853-20-05	107	30-993-10-06	99	31-412-12-05	128	31-990-11-06	118
30-853-20-06	107			31-412-12-06	128	31-990-20-06	119
30-858-10-06	87	31-201-10-05	125	31-412-13-06	128	31-990-21-06	119
30-858-20-06	87	31-201-10-06	125	31-413-10-06	129	31-990-22-06	119
30-866-10-05	89	31-201-11-06	125	31-414-10-06	128	31-990-23-06	119
30-866-10-06	89	31-211-10-06	125	31-414-11-05	128		
30-869-10-06	86	31-211-11-06	125	31-414-11-06	128	32-854-10-06	147
30-892-10-05	95	31-231-10-06	118, 125	31-414-12-05	128	32-854-10-21	147
30-892-10-06	95	31-231-11-06	118, 125	31-414-12-06	128	32-854-10-23	147
30-902-10-05	98	31-231-12-06	118, 125	31-415-10-06	129	32-854-11-06	147
30-902-10-06	98	31-231-13-06	118, 125	31-416-10-06	127	32-854-11-21	147
30-904-10-05	97	31-301-10-05	125	31-421-10-06	126	32-854-11-23	147
30-904-10-06	97	31-301-10-06	125	31-422-10-06	128	32-866-10-06	151
30-904-20-05	97	31-301-11-05	125	31-422-11-05	128	32-866-11-21	151
30-904-20-06	97	31-301-11-06	125	31-422-11-06	128	32-904-10-06	156
30-905-21-05	89	31-301-12-05	125	31-422-12-05	128	32-904-11-06	156
30-905-21-06	89	31-301-12-06	125	31-422-12-06	128	32-904-20-06	156
30-916-10-05	91	31-301-13-05	125	31-431-10-05	127	32-904-21-06	156
30-916-10-06	91	31-301-13-06	125	31-431-10-06	127	32-905-22-06	151
30-931-40-05	108	31-302-10-05	128	31-432-10-06	129	32-905-23-21	151
30-931-40-12	108	31-302-10-06	128	31-432-11-05	129	32-916-10-06	152
30-931-40-15	108	31-302-11-05	128	31-432-11-06	129	32-916-11-21	152
30-931-40-20	108	31-302-11-06	128	31-432-12-05	129	32-952-10-06/01	161
30-931-40-41	108	31-302-12-05	128	31-432-12-06	129	32-952-10-06/21	161
30-931-40-48	108	31-302-12-06	128	31-433-10-06	130	32-958-10-06	155
30-931-40-49	108	31-302-13-06	128	31-441-10-06	127	32-958-20-06	155
30-931-41-15	108	31-302-30-05	128	31-451-10-06	127	32-968-10-06	155
30-931-41-20	108	31-302-30-06	128	31-461-10-06	130	32-973-10-06	153
30-931-41-41	108	31-302-31-05	128	31-501-10-05	127	32-973-11-06	153
30-931-41-48	108	31-302-31-06	128	31-501-10-06	127		
30-931-41-49	108	31-302-32-05	128	31-501-11-05	127	33-201-10-06	167
30-935-10-06/21	113	31-302-32-06	128	31-501-11-06	127	33-201-10-21	167
30-952-10-06/01	110	31-302-33-06	128	31-501-12-05	127	33-201-11-06	167
30-952-10-06/21	110	31-311-10-05	125	31-501-12-06	127	33-201-11-21	167

Artikel Item	Seite Page	Artikel Item	Seite Page	Artikel Item	Seite Page	Artikel Item	Seite Page
33-201-20-06	167	<b>60-101-10-21</b>	241	60-442-10-06	193	G20-931-41-48	47, 159
33-201-20-21	167	60-101-11-21	241	60-625-00-00	242	G20-931-41-49	47, 159
33-201-21-06	167	60-101-12-21	241	60-626-10-21	238		
33-201-21-21	167	60-101-13-21	241	60-626-10-23	238	<b>G71-845-10-12</b>	56
33-301-10-06	167	60-101-14-21	241	60-626-11-21	239	G71-845-10-17	56
33-301-10-21	167	60-112-10-21	240	60-627-11-21	239	G71-845-10-18	56
33-301-11-06	167	60-113-13-21	241	60-671-00-00	242	G71-845-10-19	56
33-301-11-21	167	60-116-10-21	240			G71-845-10-21	56
33-301-12-06	167	60-116-11-21	240	<b>62-111-11-01</b>	181, 215	G71-845-10-23	56
33-301-12-21	167	60-116-12-21	240	62-202-10-05	244	G71-845-10-41	56
33-301-13-06	167	60-126-10-06	206	62-202-10-06	244	G71-851-10-18	62
33-301-13-21	167	60-126-11-05	206	62-202-10-12	244	G71-851-10-19	62
33-331-10-06	168	60-126-11-06	206	62-211-10-21	245	G71-851-10-21	62
33-331-10-21	168	60-126-12-05	206	62-211-10-25	245	G71-851-10-23	62
33-401-10-06	168, 169	60-126-12-06	206	62-211-10-32	245	G71-851-20-18	63
33-401-10-21	168, 169	60-127-10-21	206	62-211-10-34	245	G71-851-20-19	63
33-401-11-06	168, 169	60-127-11-21	206	62-211-10-38	245	G71-851-20-21	63
33-401-11-21	168, 169	60-127-12-21	206	62-211-11-45	245	G71-851-20-23	63
33-404-10-06	168	60-132-10-05	207	62-212-10-21	245	G71-851-30-18	64
33-404-10-21	168	60-132-10-06	207	62-212-11-45	245	G71-851-30-19	64
33-404-12-06	168	60-133-10-05	207	62-213-10-21	245	G71-851-30-21	64
33-404-12-21	168	60-133-10-06	207	62-214-10-06	96, 155	G71-851-30-23	64
33-424-10-06	169	60-141-10-05	207	62-214-10-21	96, 155		
33-424-10-21	169	60-141-10-06	207	62-222-10-24	43, 147	<b>T31-641-10-06</b>	115
33-424-30-06	169	60-142-03-06	73	62-222-10-33	43, 147		
33-424-30-21	169	60-142-03-21	73	62-222-10-35	43, 147	<b>T71-846-10-18/17</b>	59
33-453-10-06	168	60-142-03-23	73	62-222-10-37	43, 147	T71-846-10-18/19	59
33-453-10-21	168	60-142-04-06	73	62-222-10-46	43, 147	T71-846-10-21/16	59
33-453-11-06	168, 169	60-142-04-21	73	62-232-10-06	245	T71-846-10-21/21	59
33-453-11-21	168, 169	60-142-04-23	73	62-232-10-23	245	T71-846-10-23/16	59
33-453-20-06	168	60-142-10-21	73	62-301-02-23	131, 201	T71-846-10-23/17	59
33-453-20-21	168	60-142-11-06	73	62-303-01-05	130, 199	T71-846-10-23/19	59
33-453-21-06	168	60-142-12-23	73	62-303-01-06	130, 199	T71-846-10-23/23	59
33-453-21-21	168	60-142-14-21	73			T71-847-10-18/17	58
33-453-31-06	169	60-142-15-06	73	<b>71-850-11-16</b>	61	T71-847-10-18/19	58
33-453-31-21	169	60-142-16-23	73	71-850-11-17	61	T71-847-10-21/16	58
33-461-10-21	168	60-142-50-21	73	71-850-11-18	61	T71-847-10-21/21	58
33-461-10-23	168	60-142-51-06	73	71-850-11-19	61	T71-847-10-23/16	58
33-461-11-21	168	60-142-52-23	73	71-850-11-21	61	T71-847-10-23/17	58
33-461-11-23	168	60-142-54-21	73	71-850-11-23	61	T71-847-10-23/19	58
33-551-10-06	169	60-142-55-06	73			T71-847-10-23/23	58
33-551-10-21	169	60-142-56-23	73	<b>94-904-10-01</b>	97, 156	T71-848-10-18/17	57
33-551-11-06	169	60-211-10-21	242	94-904-10-21	97, 156	T71-848-10-18/19	57
33-551-11-21	169	60-211-11-21	241	94-904-10-42	97, 156	T71-848-10-21/16	57
33-551-20-06	169	60-211-12-21	241			T71-848-10-21/21	57
33-551-20-21	169	60-211-20-06	241	<b>D33-624-10-06</b>	163	T71-848-10-23/16	57
33-551-21-06	169	60-211-21-06	241	D33-624-10-21	163	T71-848-10-23/17	57
33-551-21-21	169	60-211-22-06	241	D33-624-10-23	163	T71-848-10-23/19	57
33-601-10-06	169	60-211-23-21	242			T71-848-10-23/23	57
33-601-10-21	169	60-211-24-21	242	<b>G20-885-12-05</b>	50, 157	T71-849-10-21	65
33-621-10-06	163	60-211-31-10	242	G20-885-12-12	50, 157	T71-849-20-21	65
33-621-10-06	235	60-211-40-10	238	G20-885-12-21	50, 157		
33-621-10-21	163	60-311-10-00	77	G20-931-41-05	47, 159		
33-621-10-21	235	60-312-10-00	77	G20-931-41-12	47, 159		
33-624-10-06	163	60-312-11-00	77	G20-931-41-15	47, 159		
33-624-10-21	163	60-435-10-05	193	G20-931-41-20	47, 159		
33-624-10-23	163	60-435-10-06	193	G20-931-41-23	47, 159		
33-651-10-21	169	60-442-10-05	193	G20-931-41-41	47, 159		

# BESTELLINFORMATIONEN UND TECHNISCHE HINWEISE

## ORDERING INFORMATION AND TECHNICAL INFORMATION

### LED LEUCHTEN

Bei Leuchten mit integrierter LED-Technik können die Leuchtmittel nur vom Hersteller ausgetauscht werden.

### KONVENTIONELLE LEUCHTMITTEL

Angaben zu Leuchtmitteln entsprechen dem Lampen-Bezeichnungssystem (LBS) des ZVEI.

### RETROFIT LEUCHTMITTEL

Kompatibilitätsangaben von Retrofit-Leuchtmitteln beziehen sich auf die technischen Eigenschaften der verbaute Fassung bzw. des verbauten Transformators und müssen kundenseitig individuell geprüft werden.

### LICHTWERTE

Alle Angaben zu Lumen entsprechen tatsächlich gemessenen Werten bei Betriebstemperatur der Leuchte. Nominalangaben der LED-Hersteller liegen bis zu 20 % höher. Werte werden gerundet dargestellt.

### LICHTVERTEILUNGSKURVEN

Gerne stellen wir Ihnen Lichtverteilungskurven in gängigen Dateiformaten zur Verfügung. Wenden Sie sich dafür bitte an die Abteilung Lichtplanung.

### OBERFLÄCHEN, FARBEN UND MATERIALIEN

Alle Angaben zu Oberflächen sind ausschließlich Farbangaben und keine Werkstoffbezeichnungen. Die Metalloberflächen unserer Produkte werden je nach Werkstoff und gewünschter Wirkung mit unterschiedlichen Fertigungsverfahren veredelt. Hierbei nutzen wir Methoden wie Polieren, Lackieren, Eloxieren oder Galvanisieren. Gläser sind in der Regel außen sandtiniert und innen reflektionsbeschichtet. Einige Gläser sind mundgeblasen und handwerkliche Einzelanfertigungen mit individuellem Charakter. Kleinere Abweichungen sind unvermeidbar.

### SCHUTZART

Leuchten sind technisch – wenn nicht anders angegeben – grundsätzlich nach Schutzart IP 20 ausgeführt. Alle Transformatoren und Netzteile mit Sicherheits-Kleinspannung (SELV). Lichtsysteme sind nur für Anwendungen im Innenraum zugelassen. Feuchträume oder Nasszellen sind hiervon ausgeschlossen.

### LIEFERUMFANG

Leuchten mit konventioneller Fassung werden grundsätzlich ohne Leuchtmittel ausgeliefert. Zubehör ist grundsätzlich separat zu bestellen.

### BEZUGSQUELLEN

Produkte von OLIGO sind ausschließlich über unsere Fach- und Großhandelspartner zu beziehen. Eine Händlerübersicht ist unter [www.oligo.de](http://www.oligo.de) zu finden.

### ANGEBOTE

Angebote sind freibleibend und werden nur durch unsere schriftliche Bestätigung unter Zugrundelegung unserer AGB wirksam. Mündliche Vereinbarungen bedürfen der schriftlichen Bestätigung.

### SONDERANFERTIGUNGEN

Für Sonderausführungen unserer Artikel wenden Sie sich bitte an unseren Kundenservice.

### GÜLTIGKEIT

Mit Erscheinen dieses Kataloges bzw. der Preisliste werden alle vorherigen Unterlagen ungültig. Für die vorgenannte Wirksamkeit gilt im Zweifel der Tag der Bestellung.

### ZUSÄTZLICHE INFORMATIONEN

Für viele OLIGO Lichtsysteme und Leuchten sind nationale und internationale Schutzrechte wie Patente, Gebrauchsmuster, Geschmacks- oder Markenrechte eingetragen. Jegliche Informationen dieses Kataloges – insbesondere die Abbildungen – dürfen nur nach vorheriger schriftlicher Genehmigung vervielfältigt werden.

### DISCLAIMER

Technische Änderungen vorbehalten. Für die Richtigkeit technischer Angaben sowie Farbabweichungen wird keine Gewähr übernommen.

### TYPISCHE MASSEINHEITEN UND ABKÜRZUNGEN

cd	=	Candela
lm	=	Lumen
K	=	Kelvin
CRI	=	Farbwiedergabeindex
V	=	Volt
VA	=	Voltampere
AC	=	Wechselstrom
DC	=	Gleichstrom
Hz	=	Hertz
W	=	Watt
RAL	=	Genormter Farbwert

### SCHUTZKLASSEN NACH DIN 40 100 (EC-Publ. 417)

#### Schutzklasse 1

Berührbare Metallteile am Schutzleiter der Leuchte angeschlossen.

#### Schutzklasse 2

Stromführende Teile sind zusätzlich isoliert und können im Fehlerfall nicht berührt werden.

#### Schutzklasse 3

Schutzkleinspannung (SELV).



**LED LUMINAIRES**

In the case of luminaires with integrated LED technology, the light sources can only be replaced by the manufacturer.

**CONVENTIONAL LAMPS**

Information regarding lamps complies with the ZVEI [Central Association of the Electrical and Electronics Industry] lamp designation system (LBS).

**RETROFIT LAMPS**

Compatibility specifications of retrofit lamps refer to the technical properties of the installed socket and/or the installed transformer and must be checked individually by the customer.

**LIGHT VALUES**

For luminaires with integrated LEDs, all lumen information comprises actual measures values at operating temperature for the luminaire. Nominal information from the LED manufacturer is up to 20% higher.

**LIGHT DISTRIBUTION CURVES**

We will be happy to provide you with light distribution curves in common file formats. Please contact the lighting design department.

**SURFACES, COLOURS AND MATERIALS**

All information regarding surfaces are merely colour information and do not specify material designation. The metal surfaces of our products are refined using different manufacturing processes, depending on the material and the desired effect. We use methods such as polishing, lacquering, anodising or galvanising. Shades are generally satin finished on the outside and reflection coated on the inside. Some shades are hand-blown and hand crafted single unit products with individual character. Small differences are unavoidable.

**PROTECTION CLASS**

Unless otherwise, luminaires are always technically designed according to protection class IP 20. All transformers and power supply units have safety extra-low voltage (SELV). Lighting systems are only approved for indoor applications. Damp rooms or wet rooms are excluded from this.

**SCOPE OF DELIVERY**

Unless otherwise specified, luminaires are always supplied without lamps. Accessories should always be ordered separately.

**SOURCES**

Products from OLIGO should only be acquired from our specialist retail and wholesale trade partners. A retailer overview can be found at [www.oligo.de](http://www.oligo.de).

**OFFERS**

All offers are non-binding and only take effect with our written confirmation on the basis of our T&C. Verbal agreements require written confirmation. For special models of our products, please contact our customer service department.

**SPECIAL DESIGNS**

For special designs of our articles, please contact our customer service.

**VALIDITY**

All previous brochures become invalid with the publication of this catalogue. In case of doubt, the order date applies for the aforementioned effectiveness.

**LEGAL NOTE**

National and international property rights such as patents, registered designs, industrial designs or trademarks are registered for many OLIGO lighting systems and luminaires. All information in this catalogue – particularly the illustrations – may only be reproduced with prior written authorisation.

**DISCLAIMER**

Subject to technical modifications. No liability shall be accepted to the accuracy of technical information or for colour differences.

**TYPICAL UNITS OF MEASUREMENT AND ABBREVIATIONS**

cd	=	Candela
lm	=	Lumen
K	=	Kelvin
CRI	=	Colour rendering index
V	=	Volt
VA	=	Volt-ampere
AC	=	Alternating current
DC	=	Direct current
Hz	=	Hertz
W	=	Watt
RAL	=	Standardised colour value
EEC	=	Energy efficiency class

**PROTECTION CLASSES ACCORDING TO DIN 40 100 (EC Publ. 417)**

**Protection class 1**

Exposed metal parts connected to the protective earth of the luminaire.

**Protection class 2**

Live parts are additionally insulated and cannot be touched in the event of a fault.

**Protection class 3**

Safety extra-low voltage (SELV).

Die OLIGO Lichttechnik GmbH ist Partner in folgenden Kooperationen:  
OLIGO Lichttechnik GmbH is a partner in the following cooperations:

**licht.de**

Fördergemeinschaft Gutes Licht  
Association for the Promotion of Good Lighting

**ZVEI:**

Zentralverband Elektroindustrie  
Central Association of the Electrical and Electronics Industry



OLIGO Lichttechnik GmbH  
Tannenweg 1  
53757 Sankt Augustin  
Germany

Tel. +49 2241 8958-0  
Fax +49 2241 8958-880

info@oligo.de  
www.oligo.de

Vertrieb Deutschland  
Tel. +49 22 41 8958-820  
sales@oligo.de

International Sales Office  
Tel. +49 22 41 8958-800  
international@oligo.de

